

Thank you for choosing

Excel

Undermount drawer slides



Rear brackets URMS for face frame applications
ORDER SEPARATELY

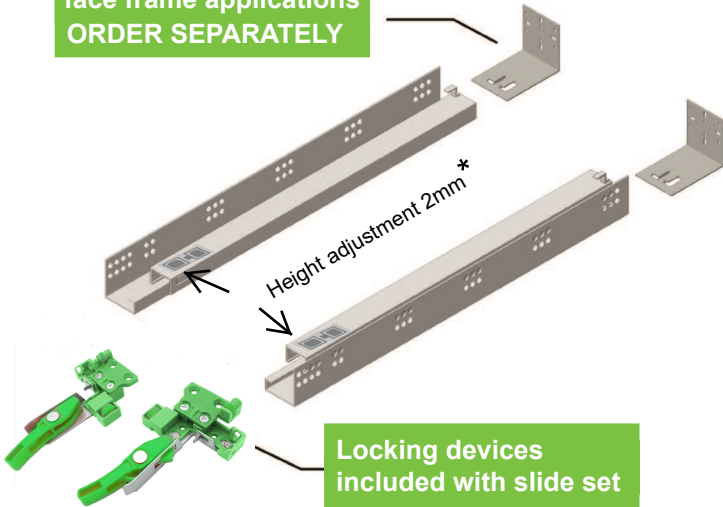

- Full extension with soft-close dampening
- Locking devices with 4-way adjustment
- 95 lb. static load capacity
- Meets KCMA & BHMA standards

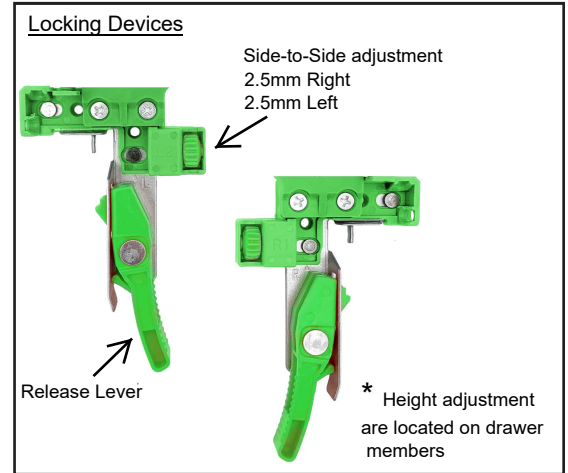

Slide mounting specifications and set part numbers

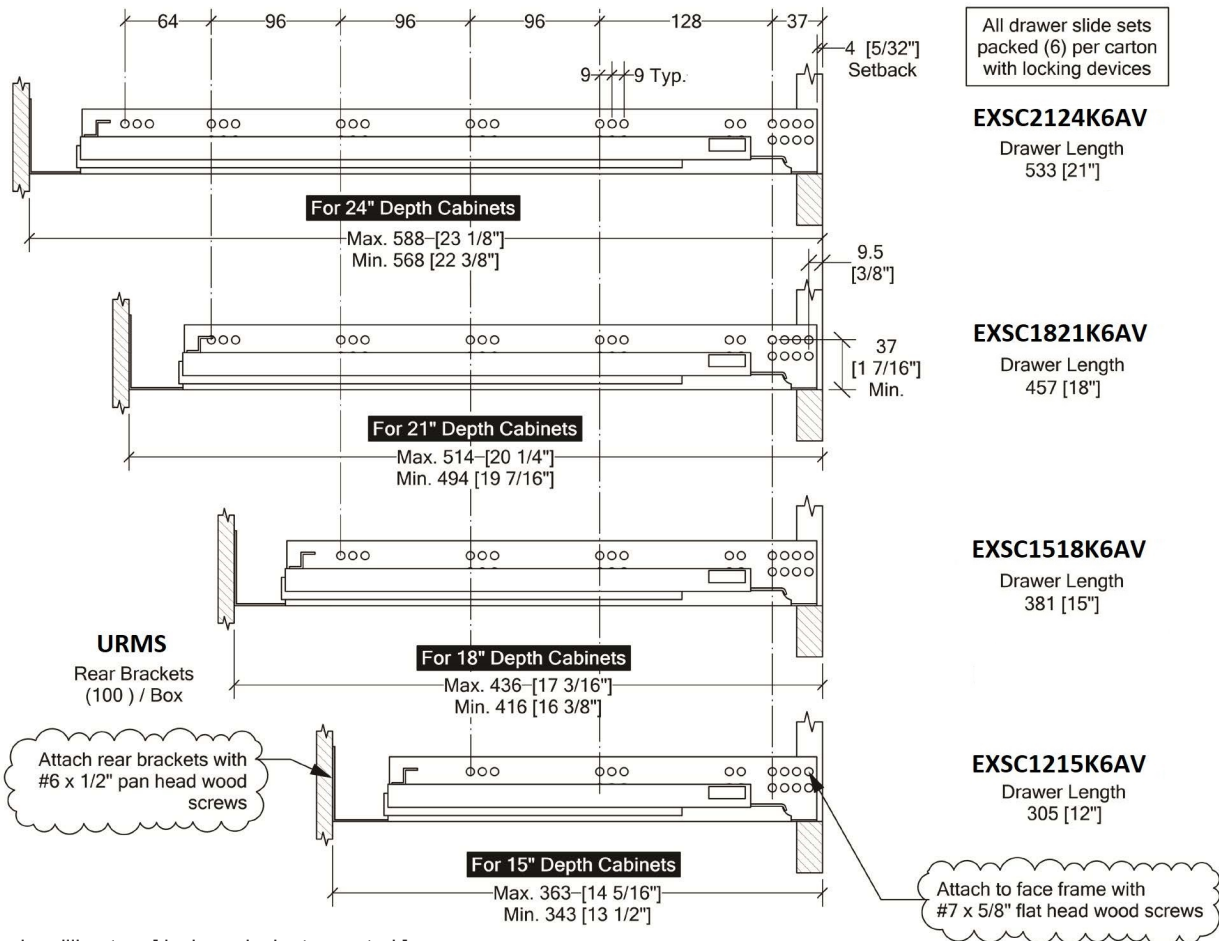

Dimensions in millimeters [inch equivalent as noted]

Specifications for

Excel

Undermount drawer slides

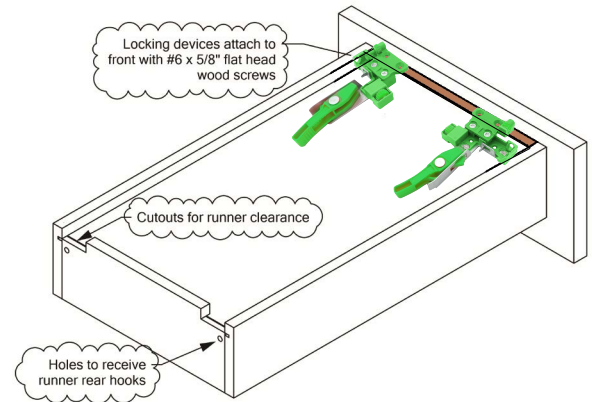
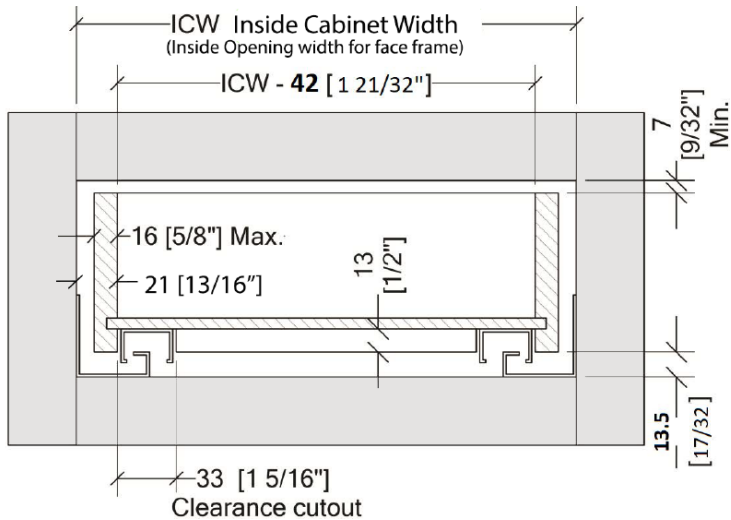

Drawer size, cutouts and rear bore dimensions

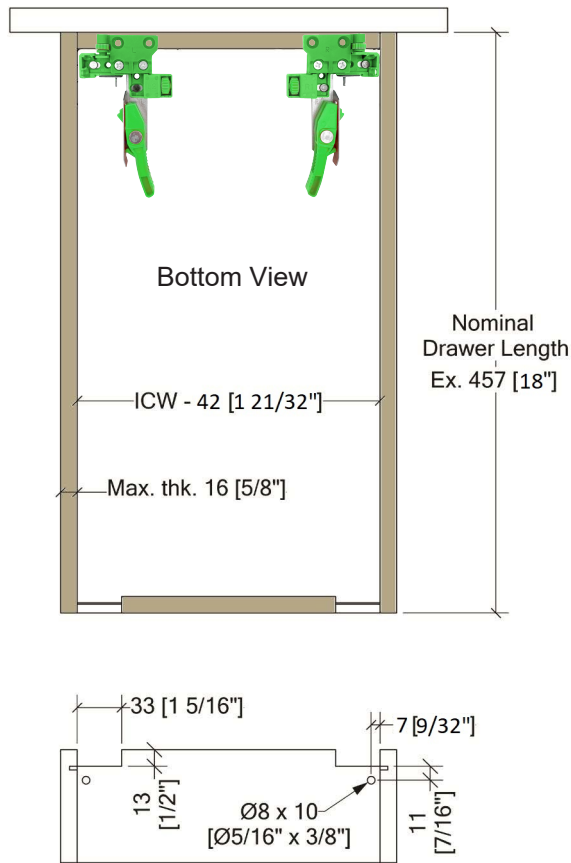

Profile installation

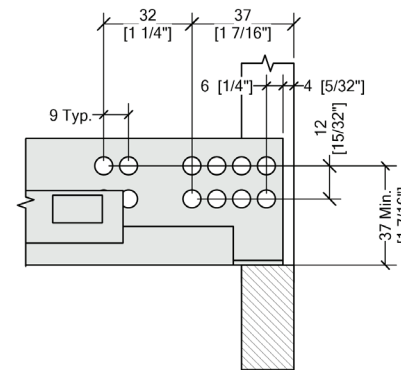

Rear bracket installation

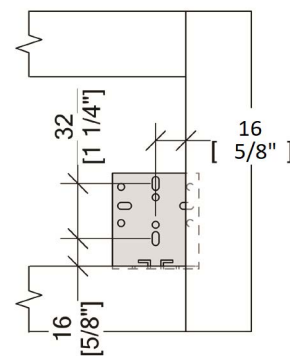

Dimensions in millimeters [inch equivalent as noted]

FGV-UDS-060219