

# DOOR HARDWARE

BI-FOLD | BY-PASS | POCKET | POCKET FRAME



# TABLE OF CONTENTS

**BIF** BI-FOLD

**BYP** BY-PASS

**PKT** POCKET

**PKF** POCKET

## BI-FOLD DOOR HARDWARE

Bi-Fold Doors . . . . . 2

Bi-Fold Series Overview . . . . . 4

BIF-20S . . . . . 6

BIF-30S . . . . . 10

BIF-50S | 50A . . . . . 14

BIF-75A . . . . . 20

BIF-100A . . . . . 24

BIF-125A . . . . . 28

Components . . . . . 32

Competitor Cross-Reference . . . . 35

## BY-PASS DOOR HARDWARE

By-Pass Doors . . . . . 36

By-Pass Series Overview . . . . . 38

BYP-50S . . . . . 40

BYP-60S . . . . . 44

BYP-60A . . . . . 48

BYP-60AFR . . . . . 52

BYP-60AFS . . . . . 56

BYP-60AFS3 . . . . . 60

BYP-60SW . . . . . 64

BYP-60AFW . . . . . 68

BYP-75AFW . . . . . 72

BYP-75S | 75A . . . . . 76

BYP-100A . . . . . 80

BYP-125A . . . . . 84

BYP-150A . . . . . 88

BYP-250A . . . . . 92

BYP-175I | 275I . . . . . 96

Components . . . . . 100

Competitor Cross-Reference . . . . 105

## POCKET DOOR HARDWARE

Pocket Doors . . . . . 106

Pocket Series Overview . . . . . 108

PKT-75S | 75A . . . . . 110

PKT-100A . . . . . 114

PKT-125A . . . . . 118

PKT-150A . . . . . 122

PKT-250A . . . . . 126

Components . . . . . 130

Competitor Cross-Reference . . . . 133

## POCKET FRAME KITS

Pocket Frames . . . . . 134

Pocket Frame Overview . . . . . 136

PKF-75S . . . . . 138

PKF-100A | 100A7 | 100A8 | 100A6W . . . . . 140

PKF-150A | 150A7 | 150A8 | 150A6W . . . . . 142

PKF-250A . . . . . 144

Components . . . . . 146

Competitor Cross-Reference . . . . 147

Calculated Door Weight . . . . . 148

Track Selection . . . . . 150

The KV Difference . . . . . 152

Commercial Warranty . . . . . 153

Return Policy . . . . . 154

Index . . . . . 155





# BI-FOLD DOORS



**Classic door hardware for bi-fold doors.  
Simple to install. Built to last.**

Knappe and Vogt offers a wide range of bi-fold door hardware sets for simple installations of 20-125 lb closet, pantry, and room dividing doors.

Bi-Fold Series Overview . . . . .	4
BIF-20S . . . . .	6
BIF-30S . . . . .	10
BIF-50S   50A . . . . .	14
BIF-75A . . . . .	20
BIF-100A . . . . .	24
BIF-125A . . . . .	28
Components . . . . .	32
Competitor Cross-Reference . . . . .	35



# BI-FOLD SERIES OVERVIEW

## BIF BI-FOLD

### Naming Structure

BIF-20S-2D-3

1	2	3	4	5
Bi-Fold	Door Weight	Track Type	Door Quantity	Opening
BIF	20	S (Steel)	2D (2 Door)	3'
	30	A (Aluminum)	4D (4 Door)	4'
	50			5'
	75			6'
	100			8'
	125			

PB-BIF-20-2

1	2	3	4
Part Bag	Bi-Fold	Door Weight	Door Quantity
PB	BIF	20	2 (2 Door)
		30	4 (4 Door)
		50	
		75	
		100	
		125	

BK = Bulk  
PB = Part Bag

### Ordering Instructions

Once the series of sliding door hardware has been identified by confirming your project's door weight and the door thickness, the next step is to go to the series page.

#### Option 1: Complete Package Sets

Order a package set that has your required door opening length. The package set includes the noted track length and hardware for installation, along with installation instructions.

#### Option 2: Tracks and Parts Bags

Order from the Tracks and Part Bags section. Choose the correct track length. Most tracks may be cut-to-size

in the field. Then choose the correct part bag based on the number of panel doors. Installation instructions are included in each part bag.

#### Individual Components

Bulk components for accessory options or replacement parts are available.

## Series Overview Matrix

		BI-FOLD						
		BIF-20S	BIF-30S	BIF-50S	BIF-50A	BIF-75A	BIF-100A	BIF-125A
Light	20 lb	•						
	30 lb		•					
	50 lb			•	•			
Standard	60 lb							
	75 lb					•		
	100 lb						•	
Heavy Duty	125 lb							•
	150 lb							
	175 lb							
	250 lb							
	275 lb							
Track		8001	9001	1599	1601	2001	2001	1801
Steel		•	•	•				
Aluminum					•	•	•	•
Fascia								
Non-Fascia		•	•	•	•	•	•	•
Type	Box	•	•	•	•	•	•	•
	Double J							
	I-Beam							
Min. Door Thickness	3/4"	•	•	•	•			
	7/8"	•	•	•	•			
	1"	•	•	•	•			
	1-1/8"	•	•	•	•			•
	1-3/8"	•	•	•	•	•	•	•
	1-3/4"	•	•	•	•	•	•	•
Carrier		Top pivot guide	Top pivot guide	1606-QR 4-wheel BB	1606-QR 4-wheel BB	2004 4-wheel	2004-BB 4-wheel	1820 4-wheel BB

This product overview matrix shows the seven hardware series in Knappe and Vogt's bi-folding door category at a glance. Using the matrix, you can compare each series to help you choose the one that will fit best for your project. Go to the series pages for more in-depth information including tracks, parts bags and components.

# BIF-20S Series

## Steel track hardware for 20 lb bi-fold doors.



**2 Door**  
2 x Door Width + 1/2"

**4 Door**  
4 x Door Width + 1"

Hardware for light-weight two and four panel bi-fold doors. The BIF-20S series is ideal for 20 lb bi-fold doors used for residential interior closets and pantries.

Door thickness: 3/4" to 1-3/4"

Load rating: Up to 20 lbs per panel (bi-fold)

Track: White steel box track

Compares to: Hettich/Grant 1500, Johnson 1825, 1838, Stanley BF20

Conforms to: ANSI/BHMA A156.14-2007  
Grade 3, D8623

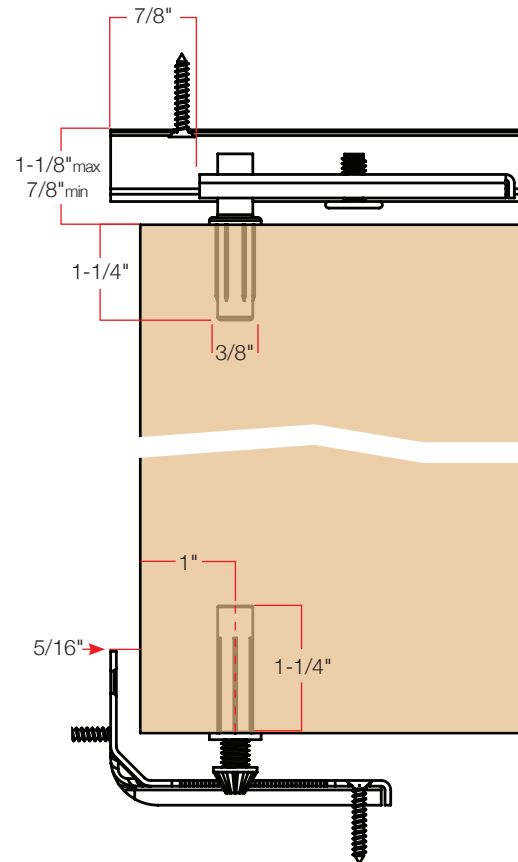
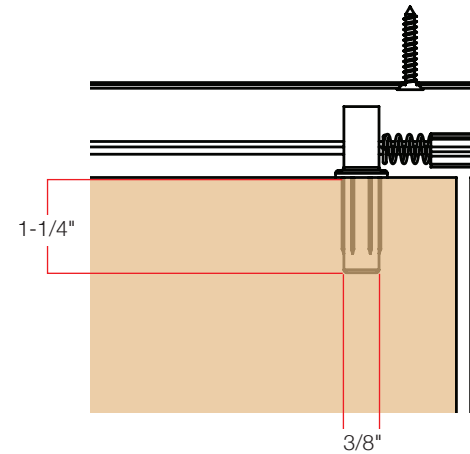

### BIF-20S series configuration

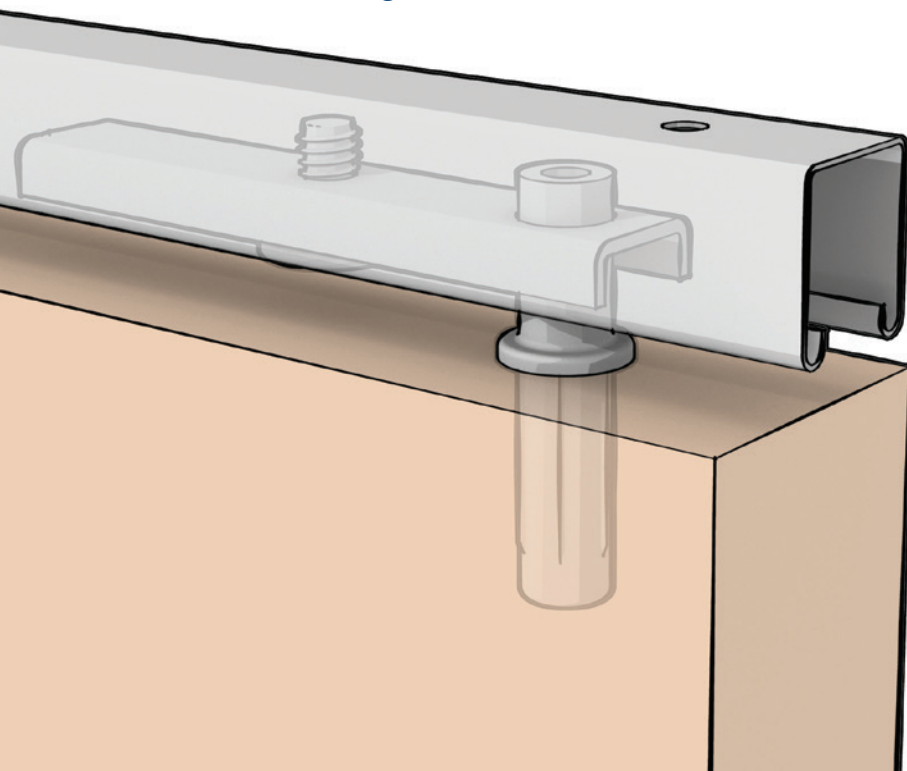

## Packaged Sets

SKU	Door Panel Configuration	Pack Qty	Pack Qty Weight (Lb)
BIF-20S-2D-3	2 x 18" doors	5	10
BIF-20S-4D-4	4 x 12" doors	10	22
BIF-20S-4D-5	4 x 15" doors	10	23
BIF-20S-4D-6	4 x 18" doors	10	25
BIF-20S-4D-8	4 x 24" doors	10	30

Hardware Contents	BIF-20S-2D-3	BIF-20S-4D-4	BIF-20S-4D-5	BIF-20S-4D-6	BIF-20S-4D-8
Track	8002-36"	8004-48"	8004-60"	8004-72"	8004-96"
Track pivot assembly-8681	1	2	2	2	2
Bottom jamb bracket-8268	1	2	2	2	2
Bottom pivot-7768	1	2	2	2	2
Top pivot and top guide-8000-TP	2	4	4	4	4
Snubber-8816-21	1	-	-	-	-
Snubber-8816-22	-	1	1	1	1
Hinge-8220-ZC	2	4	4	4	4
Wood knob-1558-R	1	2	2	2	2
Aligner-1559	-	2	2	2	2
Screws	Yes	Yes	Yes	Yes	Yes



**BIF-20S-2D**



**BIF-20S-4D**



## Tracks

SKU	Description	Pack Qty	Pack Qty Weight (Lb)
BK-8002-36	36" Steel track for 2 panels	30	20
BK-8002-48	48" Steel track for 2 panels	30	25
BK-8002-60	60" Steel track for 2 panels	30	30
BK-8004-48	48" Steel track for 4 panels	30	26
BK-8004-60	60" Steel track for 4 panels	30	31
BK-8004-72	72" Steel track for 4 panels	30	37
BK-8004-96	96" Steel track for 4 panels	30	43

Note: BK-8002 track includes one track pivot assembly 8681 for two door applications.  
BK-8004 track includes two track pivot assemblies 8681 for four door applications.



## Part Bags

SKU	Door Panels	Pack Qty	Pack Qty Weight (Lb)
PB-BIF-20-2	2	10	6
PB-BIF-20-4	4	10	12

Hardware Contents	PB-BIF-20-2	PB-BIF-20-4
Bottom jamb bracket-8268	1	2
Bottom pivot-7768	1	2
Top pivot and top guide-8000-TP	2	4
Snubber-8816-21	1	-
Snubber-8816-22	-	1
Wood knob-1558-R	1	2
Aligner-1559	-	2
Hinge-8220-ZC	2	4
Screws	Yes	Yes



**PB-BIF-20-2**



**PB-BIF-20-4**

# Components

SKU	Description	Pack Qty	Pack Qty Weight (Lb)
BK-7768	Bottom pivot	20	1
BK-8000-TP	Top pivot and top guide	20	1
BK-8220-ZC	Hinges with screws	600	54
BK-8816-21	Snubber for use with 2 panel doors	20	1
BK-8816-22	Snubber for use with 4 panel doors	20	1
PB-1558	Wood knob	24	1
PB-1559	Aligner	20	2
PB-8268	Bottom jamb bracket w/ screws	50	4
PB1064-26DA	Folding door lock, nickel, keyed alike	5	2
PB1064-US26D	Folding door lock, nickel, keyed different	5	2
PB1064-US3	Folding door lock, brass, keyed different	5	2
PB1064-US3A	Folding door lock, brass, keyed alike	5	2



BK-7768



BK-8000-TP

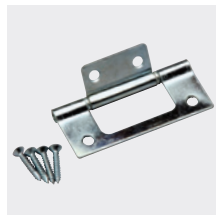

BK-8220-ZC



BK-8816-21



BK-8816-22

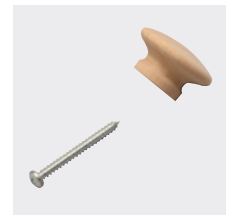

PB-1558



PB-1559



PB-8268

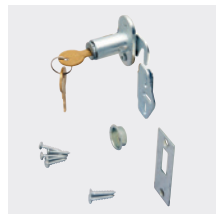

PB1064-26DA

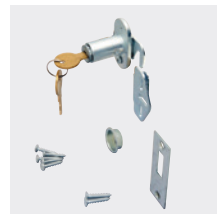

PB1064-US26D

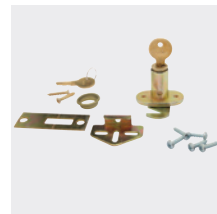

PB1064-US3



PB1064-US3A

# BIF-30S Series

## Steel track hardware for 30 lb bi-fold doors.



**2 Door**  
 2 x Door Width + 1/2"

**4 Door**  
 4 x Door Width + 1"

Hardware for lighter-weight two and four panel bi-fold doors. The BIF-30S series is ideal for 30 lb bi-fold doors used for residential interior closets, pantries, and room dividers.

- Door thickness: 3/4" to 1-3/4"
- Load rating: Up to 30 lbs per panel (bi-fold)
- Track: White steel box track
- Compares to: Hettich/Grant1500, Johnson 1825, 1838, Stanley BF30
- Conforms to: ANSI/BHMA A156.14-2007 Grade 2, D8622, D8623

### BIF-30S series configuration

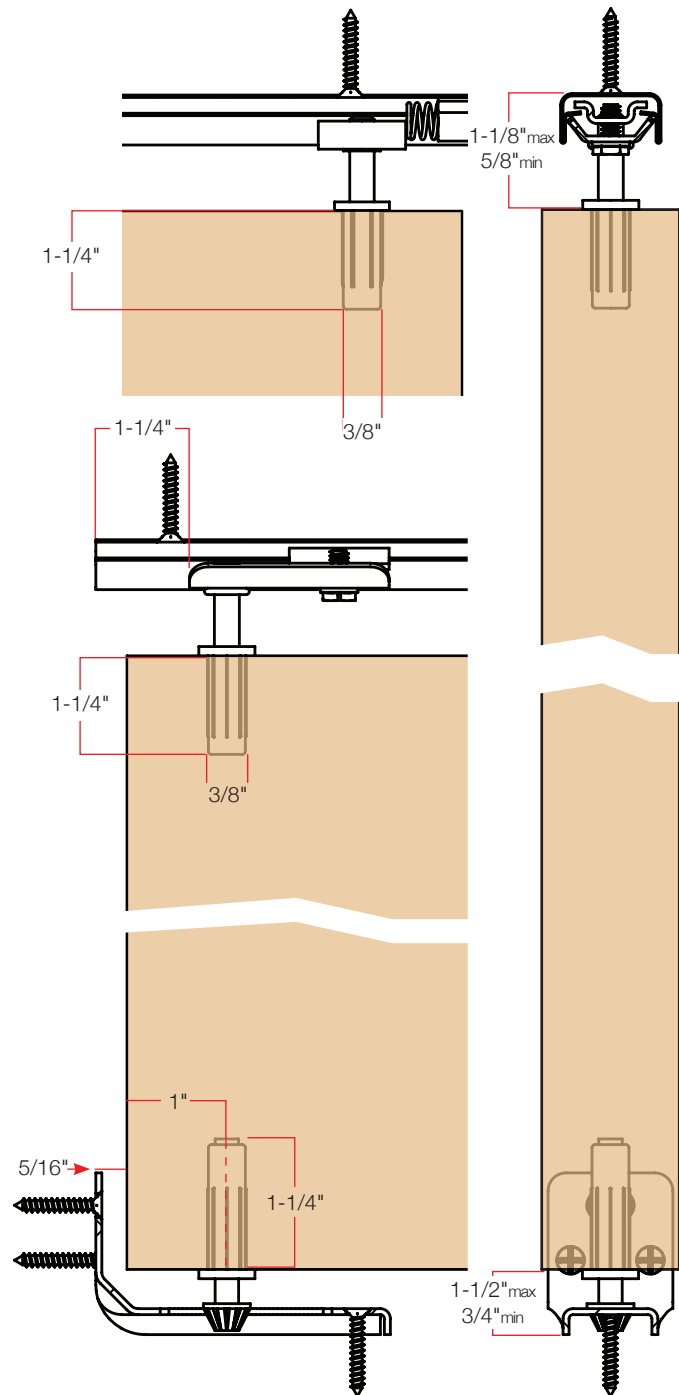
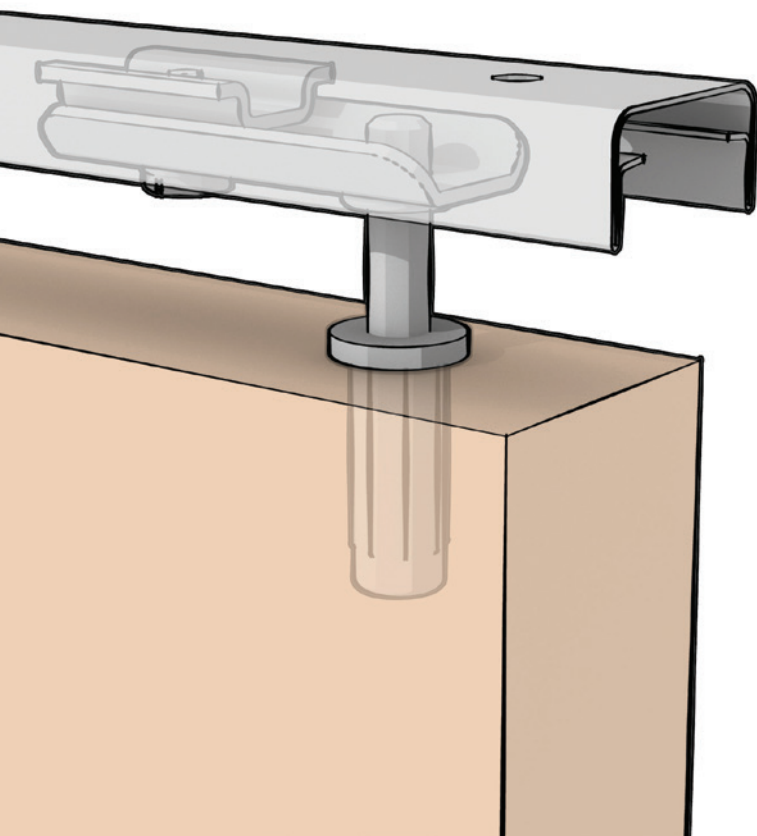

## Packaged Sets

SKU	Door Panel Configuration	Pack Qty	Pack Qty Weight (Lb)
BIF-30S-2D-3	2 x 18" doors	5	10
BIF-30S-4D-4	4 x 12" doors	5	16
BIF-30S-4D-5	4 x 15" doors	5	17
BIF-30S-4D-6	4 x 18" doors	5	18
BIF-30S-4D-8	4 x 24" doors	5	20

Hardware Contents	BIF-30S-2D-3	BIF-30S-4D-4	BIF-30S-4D-5	BIF-30S-4D-6	BIF-30S-4D-8
Track	9002-36"	9004-48"	9004-60"	9004-72"	9004-96"
Track pivot assembly-8473	1	2	2	2	2
Bottom jamb bracket-8268	1	2	2	2	2
Bottom pivot-7768	1	2	2	2	2
Top pivot guide-8404-JS	1	2	2	2	2
Top pivot-8402-JS	1	2	2	2	2
Snubber-8049-2	1	-	-	-	-
Snubber-8049-4	-	1	1	1	1
Hinge-8220-ZC	3	6	6	6	6
Wood knob-1558-R	1	2	2	2	2
Aligner-1559-ZN	-	2	2	2	2
Screws	Yes	Yes	Yes	Yes	Yes



**BIF-30S-2D**



**BIF-30S-4D**

## Tracks

SKU	Description	Pack Qty	Pack Qty Weight (Lb)
BK-9002-24	24" Low profile steel track for 2 panels	32	15
BK-9002-28	28" Low profile steel track for 2 panels	32	18
BK-9002-30	30" Low profile steel track for 2 panels	32	19
BK-9002-36	36" Low profile steel track for 2 panels	32	23
BK-9004-36	36" Low profile steel track for 4 panels	32	24
BK-9004-48	48" Low profile steel track for 4 panels	32	31
BK-9004-60	60" Low profile steel track for 4 panels	32	38
BK-9004-72	72" Low profile steel track for 4 panels	32	46
BK-9004-84	84" Low profile steel track for 4 panels	32	54
BK-9004-96	96" Low profile steel track for 4 panels	32	61

Note: BK-9002 track includes one track pivot assembly 8473 for two door applications.  
BK-9004 track includes two track pivot assemblies 8473 for four door applications.



## Part Bags

SKU	Door Panels	Pack Qty	Pack Qty Weight (Lb)
PB-BIF-30-2	2	10	6
PB-BIF-30-4	4	10	12

Hardware Contents	PB-BIF-30-2	PB-BIF-30-4
Bottom jamb bracket-8268	1	2
Bottom pivot-7768	1	2
Top pivot guide-8404-JS	1	2
Top pivot-8402-JS	1	2
Snubber-8049-2	1	-
Snubber-8049-4	-	1
Wood knob-1558-R	1	2
Aligner-1559-ZN	-	2
Hinge-8220-ZC	3	6
Screws	Yes	Yes



PB-BIF-30-2



PB-BIF-30-4

# Components

SKU	Description	Pack Qty	Pack Qty Weight (Lb)
BK-7768	Bottom pivot	20	1
BK-8049-2	Snubber for use with 2 panel doors	20	1
BK-8049-4	Snubber for use with 4 panel doors	20	1
BK-8220-ZC	Hinges with screws	600	54
BK-8402-JS	Top pivot	50	2
BK-8404-JS	Top pivot guide	50	3
PB-1558	Wood knob	24	1
PB-1559	Aligner	20	2
PB-8268	Bottom jamb bracket w/ screws	50	4
PB1064-26DA	Folding door lock, nickel, keyed alike	5	2
PB1064-US26D	Folding door lock, nickel, keyed different	5	2
PB1064-US3	Folding door lock, brass, keyed different	5	2
PB1064-US3A	Folding door lock, brass, keyed alike	5	2



**BK-7768**



**BK-8049-2**



**BK-8049-4**



**BK-8220-ZC**



**BK-8402-JS**



**BK-8404-JS**

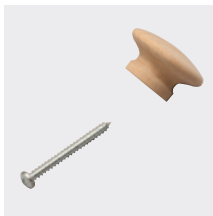

**PB-1558**



**PB-1559**



**PB-8268**

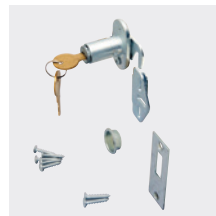

**PB1064-26DA**



**PB1064-US26D**



**PB1064-US3**



**PB1064-US3A**

# BIF-50S | 50A Series

## Steel or Aluminum track hardware for 50 lb bi-fold doors.

Hardware for medium to light-weight two and four panel bi-fold doors. The BIF-50S (steel track) and 50A (aluminum track) series are ideal for 50 lb bi-fold doors used for residential interior closets and pantries.

- Door thickness: 3/4" to 1-3/4"
- Load rating: Up to 50 lbs per panel (bi-fold)
- Track: 50S steel box track; 50A aluminum box track
- Carrier: 4-wheel ball bearing
- Compares to: Hettich/Grant 1600, Johnson 170A, 1700, 1770, 1718, 1734, 1738, IIFD Stanley BF50
- Conforms to: ANSI/BHMA A156.14-2007 Grade 1, D8621, D8622, D8623

### BIF-50S/50A series configuration

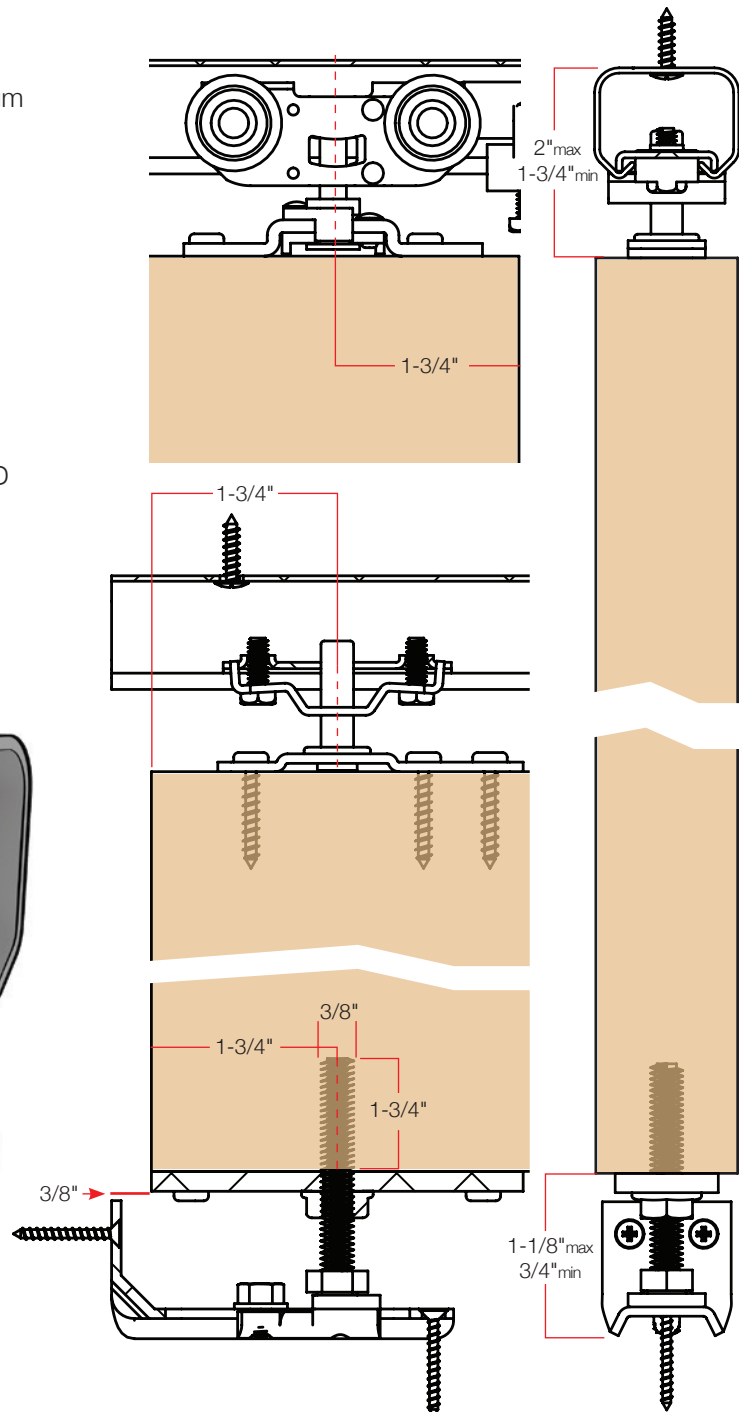
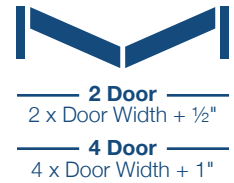
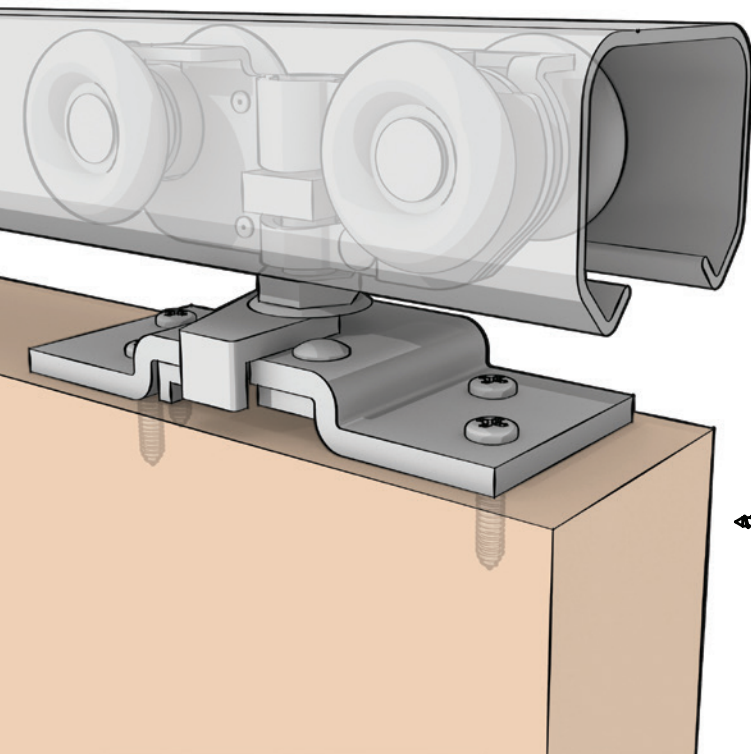

## BIF-50S Packaged Sets

SKU	Door Panel Configuration	Pack Qty	Pack Qty Weight (Lb)
BIF-50S-2D-3	2 x 18" doors	5	15
BIF-50S-4D-4	4 x 12" doors	5	23
BIF-50S-4D-6	4 x 18" doors	5	27
BIF-50S-4D-8	4 x 24" doors	5	32

Note: Packaged sets are for 1-3/8" to 1-3/4" thick doors. For 3/4" to 1-1/8" door thicknesses, order individual tracks and part bags PB-BIF-50-2ND for two door applications and PB-BIF-50-4ND for four door applications.

Hardware Contents	BIF-50S-2D-3	BIF-50S-4D-4	BIF-50S-4D-6	BIF-50S-4D-8
Track-1599	35"	47"	71"	95"
Quick release top mount plate-1800-DBA	1	2	2	2
Aligner-1559	-	2	2	2
Wood knob-1558-R	1	2	2	2
Pivot pin plate-8582	1	2	2	2
4-wheel ball bearing carriers-1606-QR	1	2	2	2
Heavy-duty pivot assembly-3313	1	2	2	2
Hinge-8220-ZC	3	6	6	6
Door guide plate-3179	1	2	2	2
Adjusting screw assembly-1500-BPASA	1	2	2	2
Snugger-0815	1	2	2	2
Jamb bracket assembly-8643	1	2	2	2
Wrench-8665	1	1	1	1
Screws	Yes	Yes	Yes	Yes



BIF-50S-2D



BIF-50S-4D



## BIF-50A Packaged Sets

SKU	Door Panel Configuration	Pack Qty	Pack Qty Weight (Lb)
BIF-50A-2D-3	2 x 18" doors	5	15
BIF-50A-4D-4	4 x 12" doors	5	25
BIF-50A-4D-6	4 x 18" doors	5	29
BIF-50A-4D-8	4 x 24" doors	5	33

Note: Packaged sets are for 1-3/8" to 1-3/4" thick doors. For 3/4" to 1-1/8" door thicknesses, order individual tracks and part bags PB-BIF-50-2ND for two door applications and PB-BIF-50-4ND for four door applications.

Hardware Contents	BIF-50A-2D-3	BIF-50A-4D-4	BIF-50A-4D-6	BIF-50A-4D-8
Track-1601	35"	47"	71"	96"
Quick release top mount plate-1800-DBA	1	2	2	2
Aligner-1559	-	2	2	2
Wood knob-1558-R	1	2	2	2
Pivot pin plate-8582	1	2	2	2
4-wheel ball bearing carriers-1606-QR	1	2	2	2
Heavy-duty pivot assembly-3313	1	2	2	2
Hinge-8220-ZC	3	6	6	6
Door guide plate-3179	1	2	2	2
Adjusting screw assembly-1500-BPASA	1	2	2	2
Snugger-0815	1	2	2	2
Jamb bracket assembly-8643	1	2	2	2
Wrench-8665	1	1	1	1
Screws	Yes	Yes	Yes	Yes



BIF-50A-2D



BIF-50A-4D

## BIF-50S Steel Tracks

SKU	Description	Pack Qty	Pack Qty Weight (Lb)
BK-1599-Z35	35" steel track	20	20
BK-1599-Z47	47" steel track	20	27
BK-1599-Z55	55" steel track	20	38
BK-1599-Z59	59" steel track	20	40
BK-1599-Z63	63" steel track	20	44
BK-1599-Z71	71" steel track	20	49
BK-1599-Z95	95" steel track	10	32
BK-1599-Z119	119" steel track	10	40
BK-1599-Z143	143" steel track	10	48



## BIF-50A Aluminum Tracks

SKU	Description	Pack Qty	Pack Qty Weight (Lb)
BK-1601-35	35" aluminum track	10	8
BK-1601-47	47" aluminum track	10	11
BK-1601-55	55" aluminum track	10	13
BK-1601-59	59" aluminum track	10	14
BK-1601-71	71" aluminum track	10	17
BK-1601-96	96" aluminum track	10	22
BK-1601-120	120" aluminum track	10	28
BK-1601-144	144" aluminum track	10	32
BK-1601-192	192" aluminum track	10	42



## Part Bags

SKU	Door Panels	Door Thickness	Pack Qty	Pack Qty Weight (Lb)
PB-BIF-50-2	2	1-3/8" to 1-3/4"	10	14
PB-BIF-50-4	4	1-3/8" to 1-3/4"	10	29
PB-BIF-50-2ND (Narrow Door)	2	3/4" to 1-1/8"	10	12
PB-BIF-50-4ND (Narrow Door)	4	3/4" to 1-1/8"	10	27

Hardware Contents	PB-BIF-50-2	PB-BIF-50-4	PB-BIF-50-2ND	PB-BIF-50-4ND
Door thickness	1-3/8" to 1-3/4" Doors		3/4" to 1-1/8" Narrow doors	
Snugger-0815	1	2	1	2
Jamb bracket-8634	1	2	1	2
Wrench-8665	1	1	1	1
Door guide plate-3179	1	2	–	–
Door guide plate-3179-ZNND	–	–	1	2
Adjustment screw assembly-1500-BPASA	1	2	1	2
Pivot pin plate assembly-8582	1	2	1	2
Quick release top mount plate-1800-DBA	1	2	–	–
Top mount plate-1407-TMND	–	–	1	2
Wood knob-1558-R	1	2	1	2
Aligner-1559	–	2	–	2
4-wheel ball bearing carrier-1606-QR	1	2	–	–
4-wheel carrier-1572-N	–	–	1	2
Heavy-duty pivot assembly-3313	1	2	1	2
Hinge-8220-ZC	3	6	–	–
Hinge-8210	–	–	3	6
Screws	Yes	Yes	Yes	Yes



PB-BIF-50-2



PB-BIF-50-4



PB-BIF-50ND-4

# Components

SKU	Description	Pack Qty	Pack Qty Weight (Lb)
BK-0815	Stop, snugger	20	1
BK-1606-QR	4 wheel ball bearing carrier, 7/8" diameter wheels	20	4
BK-1800-DBA	Quick release top mount plate	20	2
BK-1922-144	Bottom track	5	15
BK-1922-96	Bottom track	5	10
BK-8220-ZC	Hinge w/ screws	600	54
PB-1558	Wood knob with screw	24	1
PB-1559	Aligner 1 pair	20	2
PB-1618	Top and bottom pivot assemblies	10	5
PB-1921	Roller guide	20	5
PB1064-26DA	Folding door lock, nickel, keyed alike	5	2
PB1064-US26D	Folding door lock, nickel, keyed different	5	2
PB1064-US3	Folding door lock, brass, keyed different	5	2
PB1064-US3A	Folding door lock, brass, keyed alike	5	2



BK-0815



BK-1606-QR



BK-1800-DBA

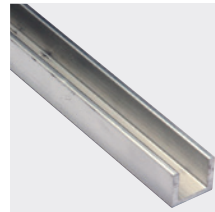

BK-1922-144

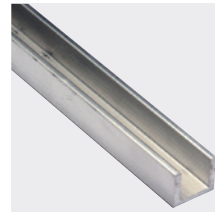

BK-1922-96



BK-8220-ZC

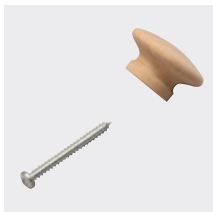

PB-1558



PB-1559



PB-1618



PB-1921

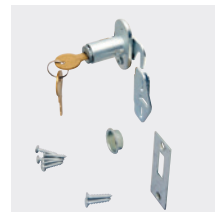

PB1064-26DA



PB1064-US26D

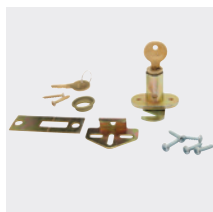

PB1064-US3



PB1064-US3A

# BIF-75A Series

## Aluminum track hardware for 75 lb bi-fold doors.



**2 Door**  
2 x Door Width + 1/2"

**4 Door**  
4 x Door Width + 1"

Hardware for medium-weight two and four panel bi-fold doors. The BIF-75A series is ideal for 75 lb bi-fold doors used for commercial and residential interior closets and pantries.

- Door thickness: 1-3/8" to 1-3/4"
- Load rating: Up to 75 lbs per panel (bi-fold)
- Track: Aluminum box track
- Carrier: 4-wheel low friction bearing
- Compares to: Johnson 100FD
- Conforms to: ANSI/BHMA A156.14-2007  
Grade 1, D8621, D8622, D8623

### BIF-75A series configuration

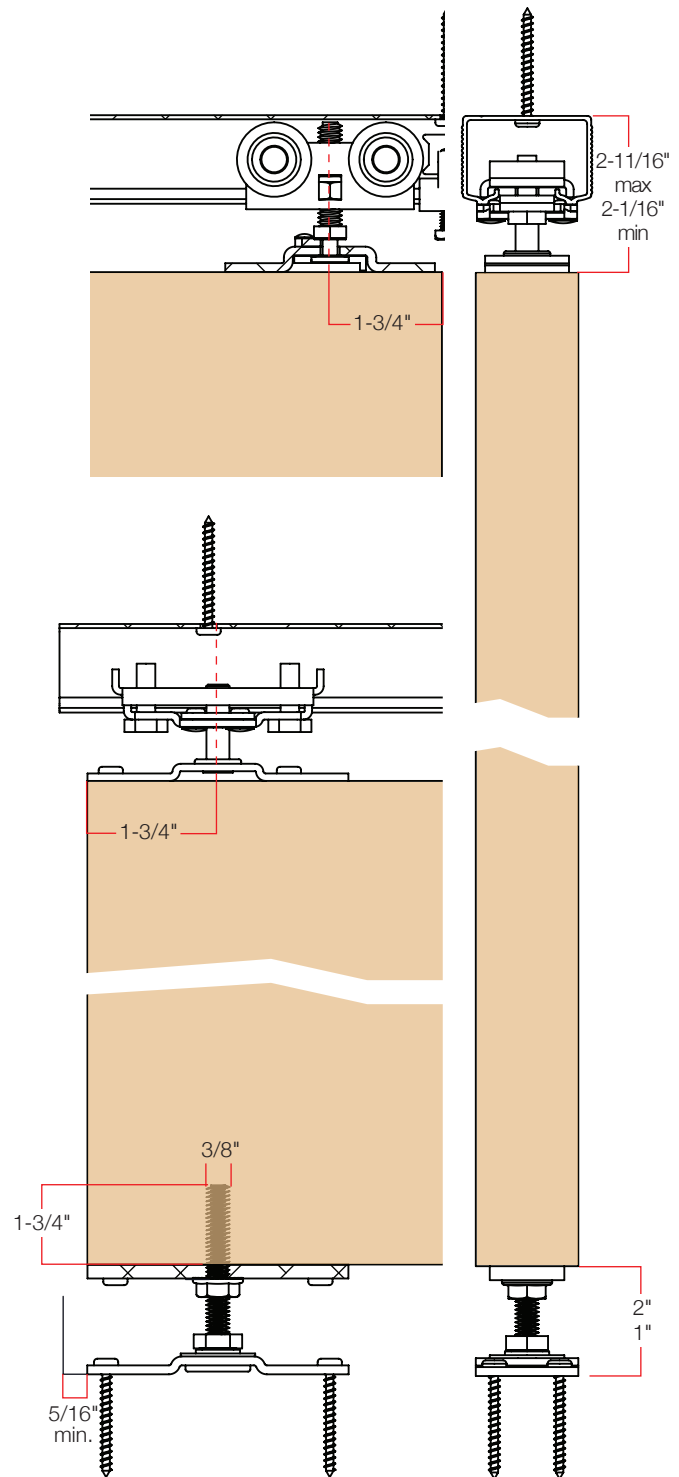
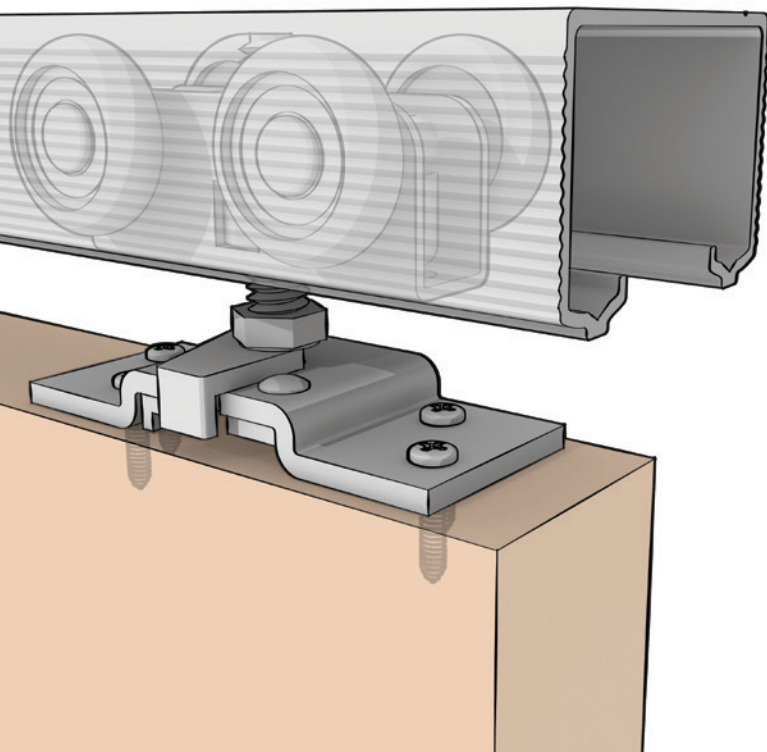

## Packaged Sets

SKU	Door Panel Configuration	Pack Qty	Pack Qty Weight (Lb)
BIF-75A-2D-3	2 x 18" doors	5	14
BIF-75A-4D-4	4 x 12" doors	5	23
BIF-75A-4D-5	4 x 15" doors	5	25
BIF-75A-4D-6	4 x 18" doors	5	28
BIF-75A-4D-8	4 x 24" doors	5	31

Hardware Contents	BIF-75A-2D-3	BIF-75A-4D-4	BIF-75A-4D-5	BIF-75A-4D-6	BIF-75A-4D-8
Track-2001	35"	47"	59"	71"	95"
Snugger-0815	1	2	2	2	2
Aligner-1559	-	2	2	2	2
Floor plate-1818-FPA	1	2	2	2	2
Track pivot bracket assembly-1800-TPBA	1	2	2	2	2
Door pivot bracket assembly-1800-DPBA	1	2	2	2	2
Quick release top mount plate-1800-DBA	1	2	2	2	2
Wrench-8710	1	1	1	1	1
Adjustment screw assembly-1800-BASAA	1	2	2	2	2
Top plate-1900-8570	1	2	2	2	2
4-wheel carrier-2004	1	2	2	2	2
Screws	Yes	Yes	Yes	Yes	Yes



**BIF-75A-2D**



**BIF-75A-4D**

## Tracks

SKU	Description	Pack Qty	Pack Qty Weight (Lb)
BK-2001-35	35" Aluminum box track	10	10
BK-2001-47	47" Aluminum box track	10	14
BK-2001-59	59" Aluminum box track	10	17
BK-2001-71	71" Aluminum box track	10	20
BK-2001-96	96" Aluminum box track	10	28
BK-2001-144	144" Aluminum box track	10	42



## Part Bags

SKU	Door Panels	Pack Qty	Pack Qty Weight (Lb)
PB-BIF-75-2	2	10	15
PB-BIF-75-4	4	10	28

Hardware Contents	PB-BIF-75-2	PB-BIF-75-4
Snugger-0815	1	2
Aligner-1559	-	2
Floor plate-1818-FPA	1	2
Track pivot bracket assembly-1800-TPBA	1	2
Door pivot bracket assembly-1800-DPBA	1	2
Quick release top mount plate-1800-DBA	1	2
Wrench-8710	1	1
Adjustment screw assembly-1800-BASAA	1	2
Top plate-1900-8570	1	2
4-wheel carrier-2004	1	2
Screws	Yes	Yes

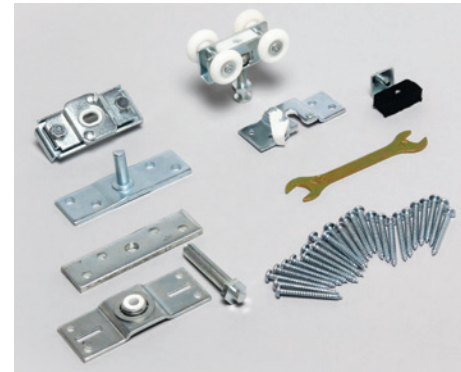

PB-BIF-75-2



PB-BIF-75-4

# Components

SKU	Description	Pack Qty	Pack Qty Weight (Lb)
BK-0815	Stop, snugger	20	1
BK-1922-144	Bottom track	5	15
BK-1922-96	Bottom track	5	10
PB-1558	Wood knob with screw	24	1
PB-1559	Aligner 1 pair	20	2
PB-1828	Top and bottom pivot assemblies	10	9
PB-1921	Roller guide	20	5
PB-2004	4-wheel carrier, 1" diam. wheels, quick release top mount plate-1800-DBA	20	4
PB1064-26DA	Folding door lock, nickel, keyed alike	5	2
PB1064-US26D	Folding door lock, nickel, keyed different	5	2
PB1064-US3	Folding door lock, brass, keyed different	5	2
PB1064-US3A	Folding door lock, brass, keyed alike	5	2



BK-0815

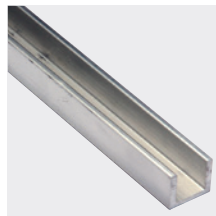

BK-1922-144

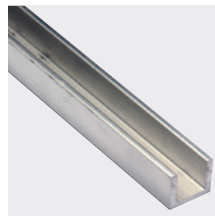

BK-1922-96

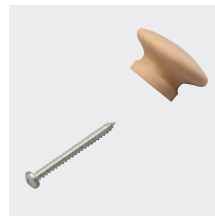

PB-1558



PB-1559



PB-1828



PB-1921



PB-2004



PB1064-26DA

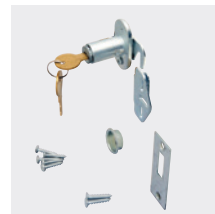

PB1064-US26D

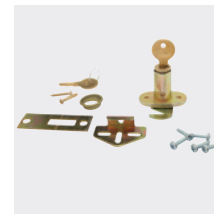

PB1064-US3

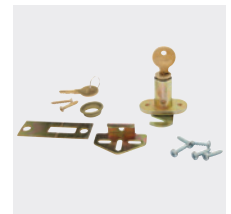

PB1064-US3A



# BIF-100A Series

## Aluminum track hardware for 100 lb bi-fold doors.

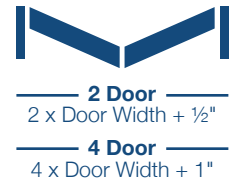

Hardware for heavy-weight two and four panel bi-fold doors. The BIF-100A series is ideal for 100 lb bi-fold doors used for a variety of commercial and residential interior applications.

- Door thickness: 1-3/8" to 1-3/4"
- Load rating: Up to 100 lbs per panel (bi-fold)
- Track: Aluminum box track with ribbing
- Carrier: 4-wheel ball-bearing
- Compares to: Johnson 100FD
- Conforms to: ANSI/BHMA A156.14-2007  
 Grade 1, D8621, D8622, D8623

### BIF-100A series configuration

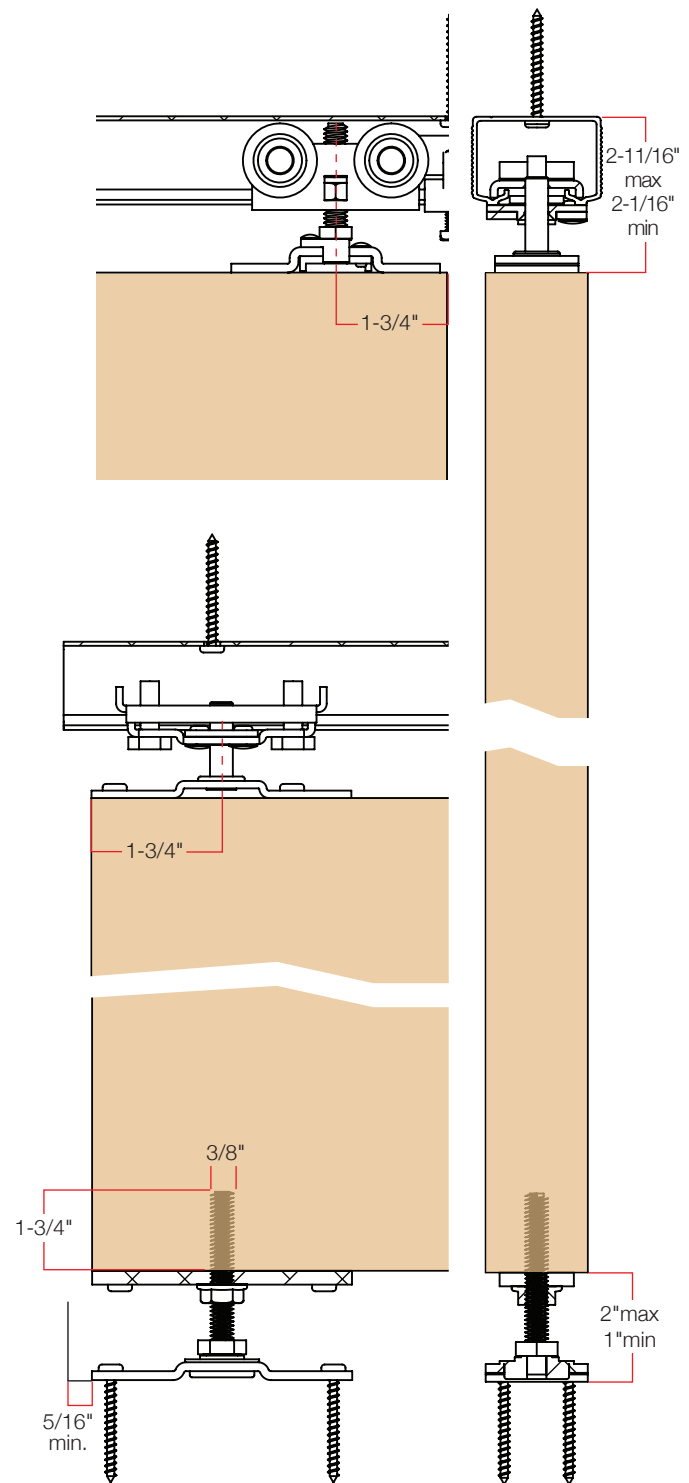
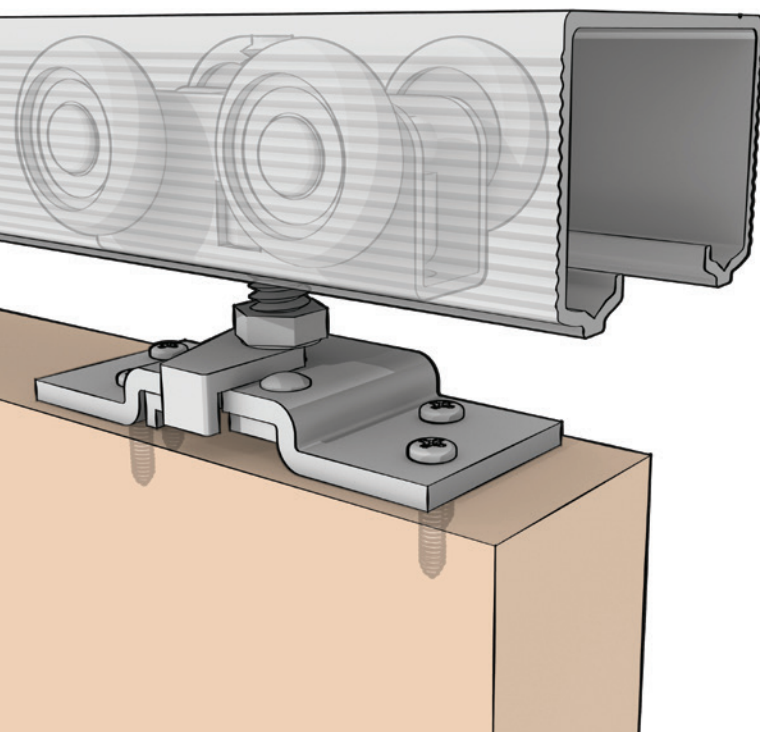

## Packaged Sets

SKU	Door Panel Configuration	Pack Qty	Pack Qty Weight (Lb)
BIF-100A-2D-3	2 x 18" doors	5	14
BIF-100A-4D-4	4 x 12" doors	5	23
BIF-100A-4D-5	4 x 15" doors	5	25
BIF-100A-4D-6	4 x 18" doors	5	28
BIF-100A-4D-8	4 x 24" doors	5	32

Hardware Contents	BIF-100A-2D-3	BIF-100A-4D-4	BIF-100A-4D-5	BIF-100A-4D-6	BIF-100A-4D-8
Track-2001	35"	47"	59"	71"	95"
Snugger-0815	1	2	2	2	2
Aligner-1559	-	2	2	2	2
Floor plate-1818-FPA	1	2	2	2	2
Track pivot bracket assembly-1800-TPBA	1	2	2	2	2
Door pivot bracket assembly-1800-DPBA	1	2	2	2	2
Quick release top mount plate-1800-DBA	1	2	2	2	2
Wrench-8710	1	1	1	1	1
Adjustment screw assembly-1800-BASAA	1	2	2	2	2
Top plate-1900-8570	1	2	2	2	2
4-wheel ball bearing carrier-2004-BB	1	2	2	2	2
Screws	Yes	Yes	Yes	Yes	Yes



**BIF-100A-2D**



**BIF-100A-4D**

## Tracks

SKU	Description	Pack Qty	Pack Qty Weight (Lb)
BK-2001-35	35" Aluminum box track	10	10
BK-2001-47	47" Aluminum box track	10	14
BK-2001-59	59" Aluminum box track	10	17
BK-2001-71	71" Aluminum box track	10	20
BK-2001-96	96" Aluminum box track	10	28
BK-2001-144	144" Aluminum box track	10	42



## Part Bags

SKU	Door Panels	Pack Qty	Pack Qty Weight (Lb)
PB-BIF-100-2	2	10	15
PB-BIF-100-4	4	10	28

Hardware Contents	PB-BIF-100-2	PB-BIF-100-4
Snugger-0815	1	2
Aligner-1559	-	2
Floor plate-1818-FPA	1	2
Track pivot bracket assembly-1800-TPBA	1	2
Door pivot bracket assembly-1800-DPBA	1	2
Quick release top mount plate-1800-DBA	1	2
Wrench-8710	1	1
Adjustment screw assembly-1800-BASAA	1	2
Top plate-1900-8570	1	2
4-wheel ball bearing carrier-2004-BB	1	2
Screws	Yes	Yes

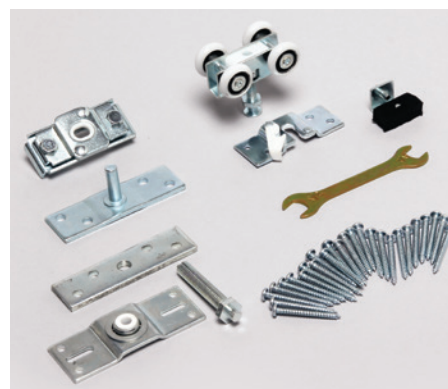

**PB-BIF-100-2**



**PB-BIF-100-4**

# Components

SKU	Description	Pack Qty	Pack Qty Weight (Lb)
BK-0815	Snugger	20	2
BK-1922-144	Bottom track	5	15
BK-1922-96	Bottom track	5	10
PB-1558	Wood knob with screw	24	1
PB-1559	Aligner 1 pair	20	2
PB-1828	Top and bottom pivot assemblies	10	9
PB-1921	Roller guide	20	5
PB-2004-BB	4-wheel ball bearing carrier, 1" diam. wheels, quick release top mount plate-1800-DBA	10	3
PB1064-26DA	Folding door lock, nickel, keyed alike	5	2
PB1064-US26D	Folding door lock, nickel, keyed different	5	2
PB1064-US3A	Folding door lock, brass, keyed alike	5	2
PB1064-US3	Folding door lock, brass, keyed different	5	2



BK-0815

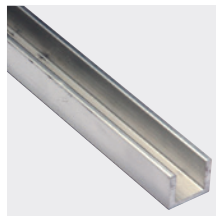

BK-1922-144

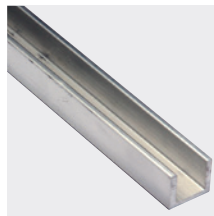

BK-1922-96

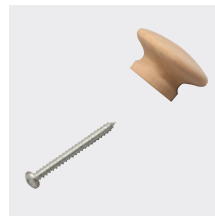

PB-1558



PB-1559



PB-1828



PB-1921



PB-2004-BB



PB1064-26DA

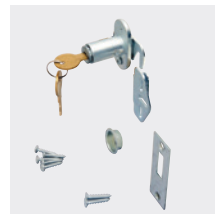

PB1064-US26D

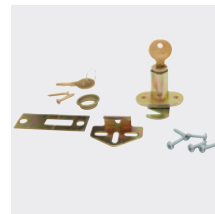

PB1064-US3



PB1064-US3A

# BIF-125A Series

## Aluminum hardware for 125 lb bi-fold doors.

Hardware for heavy-weight two and four panel bi-fold doors. The BIF-125A series is ideal for 125 lb bi-fold doors used in a wide range of commercial and residential applications.

- Door thickness: 1-1/8" to 1-3/4"
- Load rating: Up to 125 lbs per panel (bi-fold)
- Track: Aluminum box track
- Carrier: 4-wheel ball-bearing
- Compares to: Hettich/Grant 1260, Johnson 200FD, Stanley BF125N
- Conforms to: ANSI/BHMA A156.14-2007  
Grade 1, D8621, D8622, D8623



**2 Door**  
2 x Door Width + 1/2"

**4 Door**  
4 x Door Width + 1"

### BIF-125A series configuration

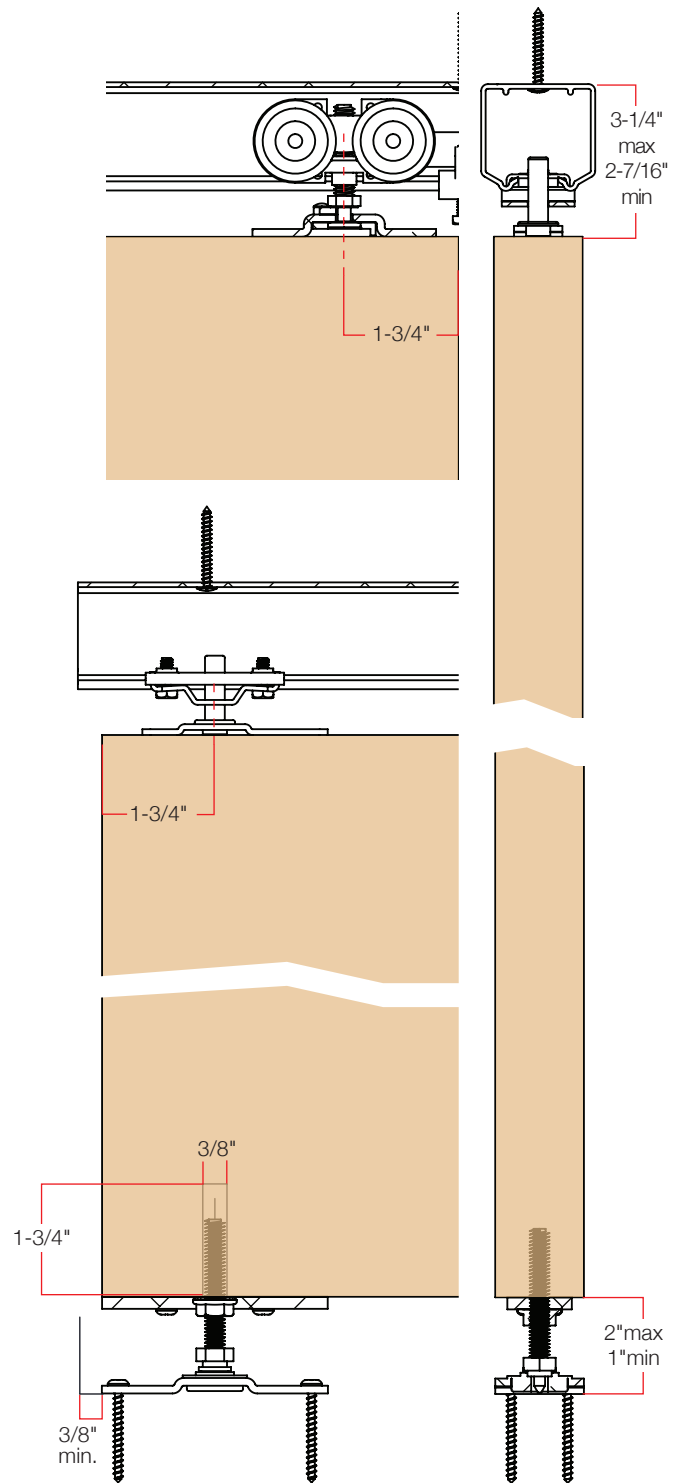
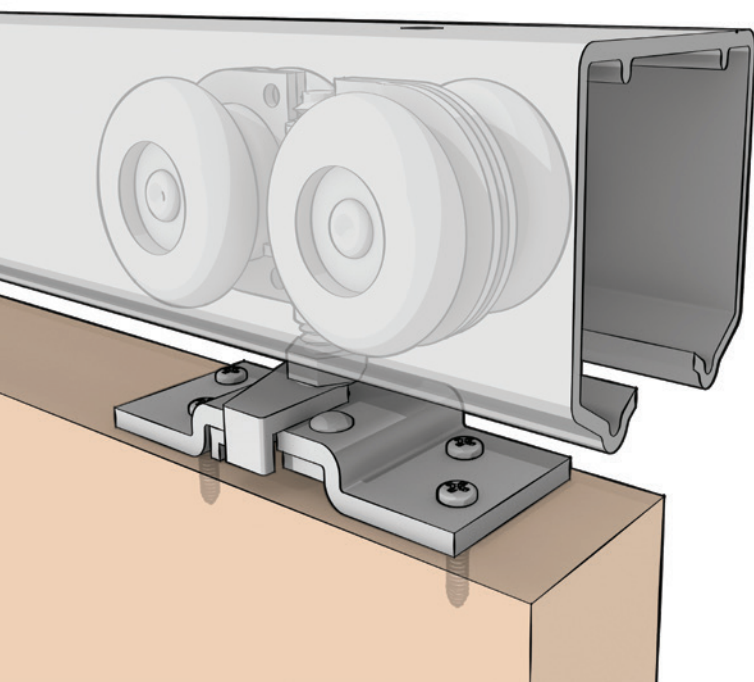

## Packaged Sets

SKU	Door Panel Configuration	Pack Qty	Pack Qty Weight (Lb)
BIF-125A-2D-3	2 x 18" doors	5	17
BIF-125A-4D-4	4 x 12" doors	5	27
BIF-125A-4D-5	4 x 15" doors	5	30
BIF-125A-4D-6	4 x 18" doors	5	32
BIF-125A-4D-8	4 x 24" doors	5	39

Hardware Contents	BIF-125A-2D-3	BIF-125A-4D-4	BIF-125A-4D-5	BIF-125A-4D-6	BIF-125A-4D-8
Track-1801	36"	48"	60"	72"	96"
Quick release top mount plate-1800-DBA	1	2	2	2	2
Wrench-8710	1	1	1	1	1
Adjustment screw assembly-1800-BASAA	1	2	2	2	2
Door pivot bracket assembly-1800-DPBA	1	2	2	2	2
Top plate-1900-8570	1	2	2	2	2
Aligner-1559	-	2	2	2	2
Track pivot bracket assembly-1800-TPBA	1	2	2	2	2
Snugger-0815	1	2	2	2	2
Floor plate-1818-FPA	1	2	2	2	2
4-wheel ball bearing carrier-1820	1	2	2	2	2
Screws	Yes	Yes	Yes	Yes	Yes

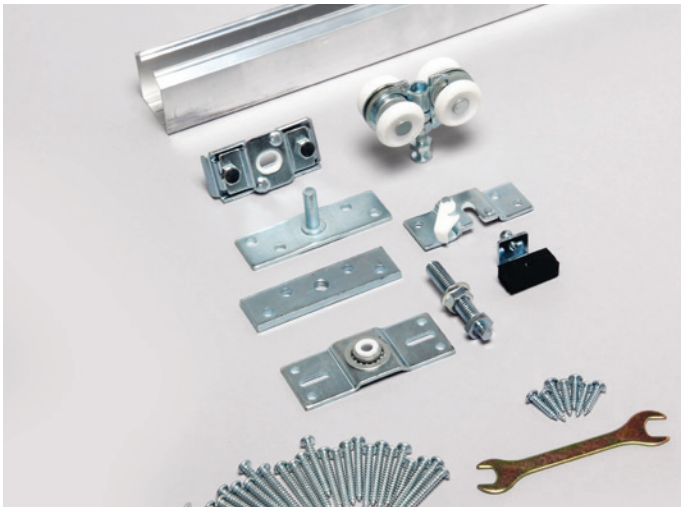

BIF-125A-2D



BIF-125A-4D

## Tracks

SKU	Description	Pack Qty	Pack Qty Weight (Lb)
BK-1801-48	48" Aluminum track	5	9
BK-1801-60	60" Aluminum track	5	12
BK-1801-72	72" Aluminum track	5	14
BK-1801-96	96" Aluminum track	5	19
BK-1801-120	120" Aluminum track	5	23
BK-1801-144	144" Aluminum track	5	28
BK-1801-192	192" Aluminum track	5	37

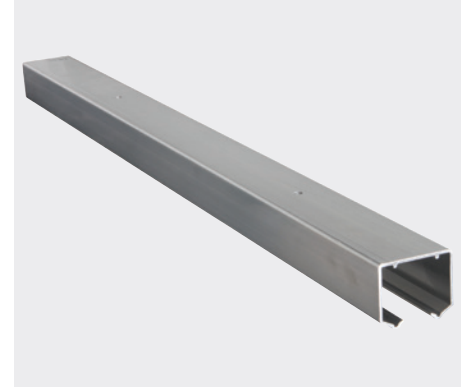

## Part Bags

SKU	Door Panels	Pack Qty	Pack Qty Weight (Lb)
PB-BIF-125-2	2	10	5
PB-BIF-125-4	4	10	10

Hardware Contents	PB-BIF-125-2	PB-BIF-125-4
Snugger-0815	1	2
Aligner-1559	–	2
Floor plate-1818-FPA	1	2
Track pivot bracket assembly-1800-TPBA	1	2
Door pivot bracket assembly-1800-DPBA	1	2
Quick release top mount plate-1800-DBA	1	2
Wrench-8710	1	1
Adjustment screw assembly-1800-BASAA	1	2
Top plate-1900-8570	1	2
4-wheel ball bearing carrier-1820	1	2
Screws	Yes	Yes



**PB-BIF-125-2**

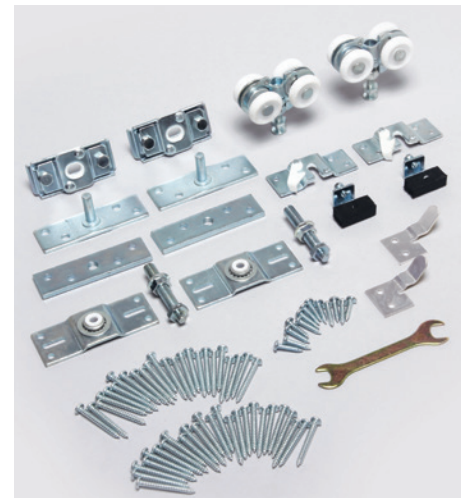

**PB-BIF-125-4**

# Components

SKU	Description	Pack Qty	Pack Qty Weight (Lb)
BK-0815	Stop, snugger	20	2
BK-1800-DBA	Quick release top mount plate	20	2
BK-1820	4-wheel ball bearing carrier, 1-1/4" diameter wheels	20	6
BK-1922-144	Bottom track	5	15
BK-1922-96	Bottom track	5	10
PB-1558	Wood knob with screw	24	1
PB-1559	Aligner 1 pair	20	2
PB-1828	Top and bottom pivot assemblies	10	9
PB-1921	Roller guide	20	5
PB1064-26DA	Folding door lock, nickel, keyed alike	5	2
PB1064-US26D	Folding door lock, nickel, keyed different	5	2
PB1064-US3A	Folding door lock, brass, keyed alike	5	2
PB1064-US3	Folding door lock, brass, keyed different	5	2



BK-0815



BK-1800-DBA



BK-1820

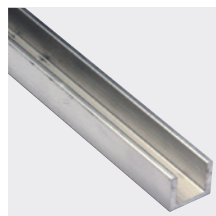

BK-1922-144

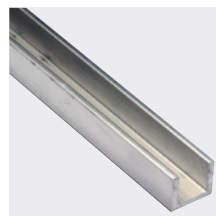

BK-1922-96

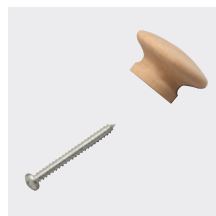

PB-1558



PB-1559



PB-1828



PB-1921

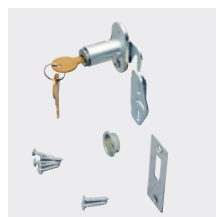

PB1064-26DA

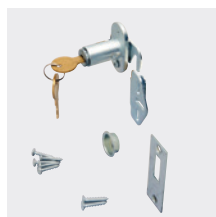

PB1064-US26D

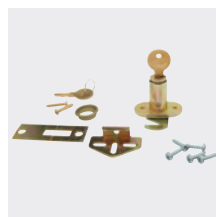

PB1064-US3



PB1064-US3A



# BI-FOLD COMPONENTS



**BK-0815** Snagger

- **Materials:** Zinc plated steel and rubber
- **Notes:** Screws onto track.



**BK-7768** Bottom pivot

- **Materials:** Steel with plastic sleeve
- **Notes:** Bottom pivot fits into jamb bracket.



**BK-1606-QR** 4-wheel ball bearing carrier

- **Materials:** Zinc with brass finish
- **Wheel:** 7/8" (22mm) diameter.
- **Notes:** Wheels self-align to allow consistent contact with track. Lubricated plastic wheels on steel shafts.



**BK-8000-TP** Top pivot and top guide

- **Materials:** Plastic
- **Notes:** Used as a pivot and guide.



**BK-1800-DBA** Quick release top mount plate

- **Materials:** Zinc plated steel
- **Notes:** Attached to door. Carrier attaches to plate. Quick release.

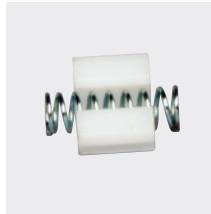

**BK-8049-2** Snubber

- **Materials:** Plastic snubber body with steel spring
- **Notes:** Snaps into track at door jamb. For use with 2 panel doors.



**BK-1820** 4-wheel ball bearing carrier

- **Materials:** Zinc plated steel
- **Wheel:** 1-1/4" (32mm) diameter
- **Notes:** Wheels self-align to allow consistent contact with track. Lubricated plastic wheels on steel shafts.



**BK-8049-4** Snubber

- **Materials:** Plastic snubber body with steel spring
- **Notes:** Snaps into track between doors. For use with 4 panel doors.

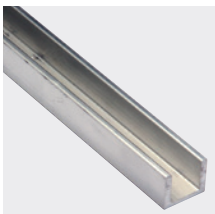

**BK-1922-144** Bottom track

- **Materials:** Extruded aluminum
- **Channel:** 5/8" x 3/4" (16mm x 19mm)
- **Notes:** Screws not provided. Mortised into floor or surface mounted. Cut to length.



**BK-8220-ZC** Hinges with screws

- **Materials:** Steel with bright zinc finish
- **Dimensions:** 3" x 1" (76mm x 25mm)
- **Notes:** Hole locator is 1/2" (13mm) from center lines of holes to center of barrel. Non-mortise hinge.

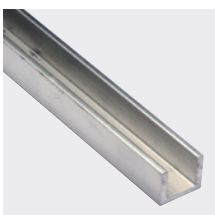

**BK-1922-96** Bottom track

- **Materials:** Extruded aluminum
- **Channel:** 5/8" x 3/4" (16mm x 19mm)
- **Notes:** Screws not provided. Mortised into floor or surface mounted. Cut to length.



**BK-8402-JS** Top pivot

- **Materials:** Steel and plastic
- **Notes:** Fits into track assembly.



**BK-8404-JS** Top guide

- **Materials:** Steel and plastic
- **Notes:** Glides across the track as a guide.



**PB-1828** Top and bottom pivot assemblies

- **Includes:** Pivot pin plate (1800-DPBA); heavy duty pivot assembly (1800-TPBA); door guide plate (1900-8570); adjusting screw (1800-BASAA); floor plate (1818-FPA); snugger (0815); and aligner (1559)



**BK-8816-21** Snubber

- **Materials:** Plastic snubber body with steel spring
- **Notes:** Snaps into track at door jamb. For use with 2 panel doors.



**PB-1921** Roller guide

- **Includes:** Adjusting screw, door guide plate, and screws



**BK-8816-22** Snubber

- **Materials:** Plastic snubber body with steel spring
- **Notes:** Snaps into track between doors. For use with 4 panel doors.



**PB-2004** 4-wheel carrier with quick release top mount plate (1800-DBA)

- **Materials:** Zinc plated steel
- **Wheels:** 1" diameter
- **Notes:** Lubricated plastic wheels.

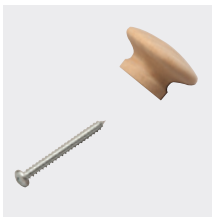

**PB-1558** Wood knob with screw

- **Materials:** Solid wood
- **Notes:** Will accept paint or stain.



**PB-2004-BB** 44-wheel ball bearing carrier with quick release top mount plate (1800-DBA)

- **Materials:** Zinc plated steel
- **Wheels:** 1" diameter
- **Notes:** Lubricated plastic wheels.



**PB-1559** Aligner, 1 pair

- **Materials:** Steel with bright zinc finish



**PB-8268** Bottom jamb bracket

- **Notes:** Screws included.



**PB-1618** Top and bottom pivot assemblies

- **Includes:** Pivot pin plate (8582); heavy-duty pivot assembly (3313); door guide plate (3179); adjusting screw (1500-BPASA); jamb bracket (8643)

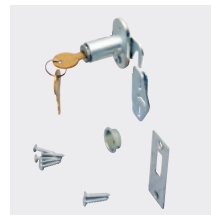

**PB1064-26DA** Bi-fold door lock

- **Materials:** Steel
- **Notes:** Nickel, keyed alike.

**PB1064-US26D** Bi-Fold door lock

- **Materials:** Steel
- **Notes:** Nickel, keyed different (5-key random).

**PB1064-US3** Bi-Fold door lock

- **Materials:** Steel
- **Notes:** Brass, keyed different (5-key random).

**PB1064-US3A** Bi-Fold door lock

- **Materials:** Steel
- **Notes:** Brass, keyed alike.

# BI-FOLD CROSS-REFERENCE

KV Series	Hettich/Grant	Johnson	Stanley
BIF-20S	1500	1825, 1838	BF20
BIF-30S	1500	1825, 1838	BF30
BIF-50S   50A	1600	170A, 1700, 1770, 1718, 1734, 1738, IIIIFD	BF50
BIF-75A	-	100FD	-
BIF-100A	-	100FD	-
BIF-125A	1260	200FD	BF125N







# BY-PASS DOORS



**Sturdy door hardware for by-pass doors.  
Simple to install. Built to last.**

Knape and Vogt offers a full range of by-passing door hardware sets for simple installations of closets, pantries and room dividers.

By-Pass Series Overview . . . . .	38
BYP-50S . . . . .	40
BYP-60S . . . . .	44
BYP-60A . . . . .	48
BYP-60AFR . . . . .	52
BYP-60AFS . . . . .	56
BYP-60AFS3 . . . . .	60
BYP-60SW . . . . .	64
BYP-60AFW . . . . .	68
BYP-75AFW . . . . .	72
BYP-75S   75A . . . . .	76
BYP-100A . . . . .	80
BYP-125A . . . . .	84
BYP-150A . . . . .	88
BYP-250A . . . . .	92
BYP-175I   275I . . . . .	96
Components . . . . .	100
Competitor Cross-Reference . . .	105

# BY-PASS SERIES OVERVIEW

## BYP BY-PASS

### Naming Structure

BYP-50S-2D-4

① — ② — ③ — ④ — ⑤

① By-Pass	② Door Weight	③ Track Type	④ Door Quantity	⑤ Opening
BYP	50	S (Steel)	2D (2 Door)	4'
	60	A (Aluminum)	4D (4 Door)	5'
	75	F (Fascia)		6'
	100	FR (Fascia Ribbed)		8'
	125	FS (Fascia Smooth)		
	150	FS3 (Fascia Smooth 3")		
	175	SW (Steel Wide)		
	250	FW (Fascia Wide)		
	275	I (I-Beam)		

PB-BYP-50-2

① — ② — ③ — ④

① Part Bag	② By-Pass	③ Door Weight	④ Door Quantity
PB	BYP	50 150	2 (2 Door)
		60 175	3 (3 Door)
		75 250	
		100 275	
		125	

BK = Bulk  
PB = Part Bag

### Ordering Instructions

Once the series of sliding door hardware has been identified by confirming your project's door weight and the door thickness, the next step is to go to the series page.

**Option 1: Complete Package Sets**  
Order a package set that has your required door opening length. The package set includes the noted track length and hardware for installation, along with installation instructions.

**Option 2: Tracks and Parts Bags**  
Order from the Tracks and Part Bags section. Choose the correct track length. Most tracks may be cut-to-size

in the field. Then choose the correct part bag based on the number of panel doors. Installation instructions are included in each part bag.

**Individual Components**  
Bulk components for accessory options or replacement parts are available.

# Series Overview Matrix

		BY-PASS																
		BYP-50S	BYP-60S	BYP-60A	BYP-60AFR	BYP-60AFS	BYP-60AFS3	BYP-60SW	BYP-60AFW	BYP-75AFW	BYP-75S	BYP-75A	BYP-100A	BYP-125A	BYP-150A	BYP-175I	BYP-250A	BYP-275I
Light	20 lb																	
	30 lb																	
	50 lb	•																
Standard	60 lb		•	•	•	•	•	•		•	•	•						
	75 lb																	
	100 lb												•					
Heavy Duty	125 lb													•				
	150 lb														•			
	175 lb															•		
	250 lb																•	
	275 lb																	•
Track		3800	3800	7810	7820-R	7820	7830	7840	5950	5950	1599	1602	1602	2001	2001	1901	1801	1901
Steel		•	•					•			•							
Aluminum				•	•	•	•		•	•		•	•	•	•	•	•	•
Fascia					•	•	•		•	•								
Non-Fascia		•	•	•				•			•	•	•	•	•	•	•	•
Type	Box										•	•	•	•	•		•	•
	Double J	•	•	•	•	•	•	•	•	•								
	I-Beam															•		•
Min. Door Thickness	3/4"	•	•	•														
	7/8"	•	•	•														
	1"	•	•	•												•		•
	1-1/8"	•	•	•												•		•
	1-3/8"	•	•	•	•	•	•	•	•	•	•	•	•	•	•	•	•	•
	1-3/4"							•			•	•	•	•	•	•	•	•
Carrier		0200 Single wheel	0400 Twin wheel	7200 Single wheel	7200-B Single wheel	7200-B Single wheel	7200-B Single wheel	7200-B Single wheel	0200-B Single wheel	0400-BTW Twin wheel	1572-QR 4-wheel	1572-QR 4-wheel	1606-QR 4-wheel BB	2004 4-wheel	2004-BB 4-wheel	8542-QR 4-wheel BB	1820 4-wheel BB	8544-QR 4-wheel BB

This product overview matrix shows the 17 hardware series in Knappe and Vogt's by-passing door category. Using the matrix, you can compare each series to help you choose the one that will fit best within your project. Go to the series pages for more in-depth information including tracks, parts bags and components.



# BYP-50S Series

## Steel track hardware for 50 lb by-pass doors.



Hardware for light to mid-weight two and three panel by-pass doors. The BYP-50S series is ideal for 50 lb by-pass doors used in residential closets, pantries, and room dividers.

Door thickness: 3/4" to 1-3/8"

Load rating: Up to 50 lbs per door

Track material: Double J steel track

Carrier: Single wheel low friction bearing

Compares to: Hettich/Grant 6034, Johnson 1166, 1138, 113F

Conforms to: ANSI/BHMA A156.14-2007  
Grade 2, D8742

### BYP-50S series configuration

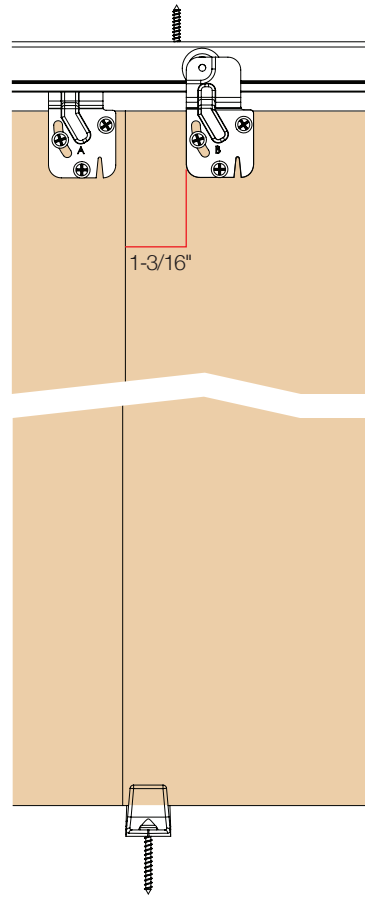
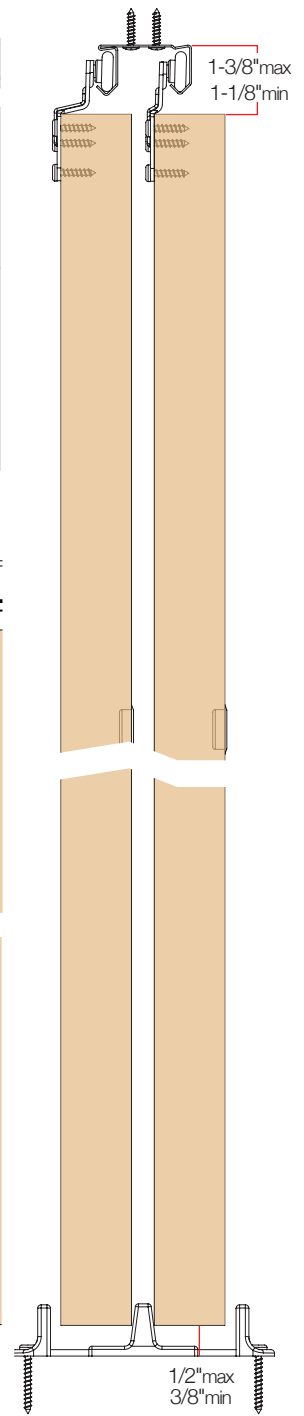
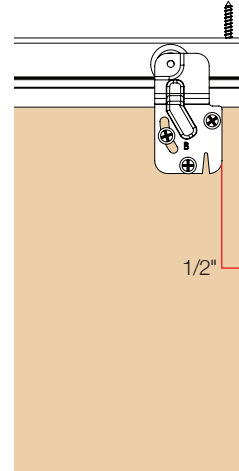
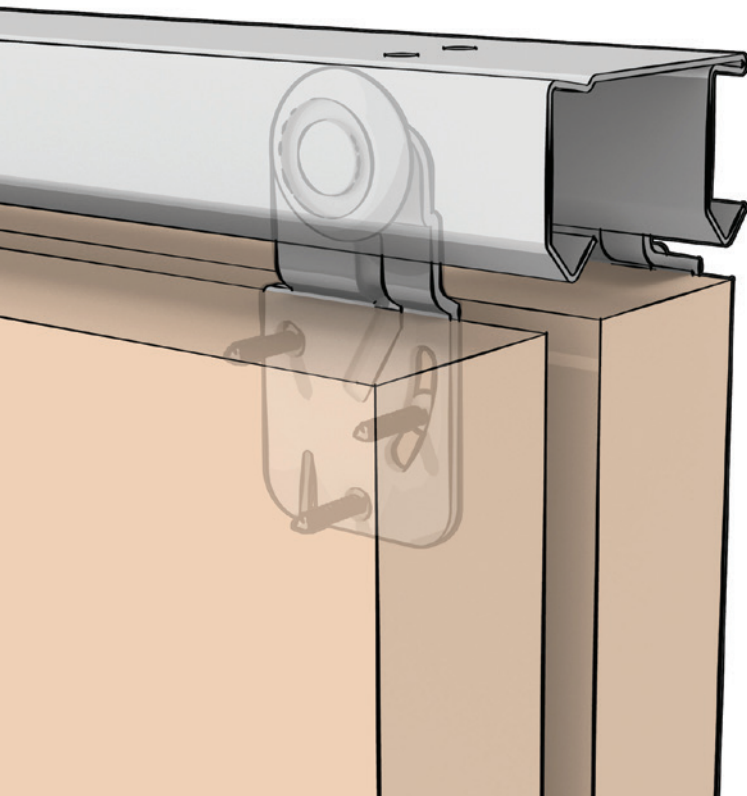

## Packaged Sets

SKU	Door Panel Configuration	Pack Qty	Pack Qty Weight (Lb)
BYP-50S-2D-4	2 x 24" doors	10	23
BYP-50S-2D-5	2 x 30" doors	10	27
BYP-50S-2D-6	2 x 36" doors	10	31
BYP-50S-2D-8	2 x 48" doors	10	38
BYP-50S-3D-8	3 x 32" doors	10	56

Note: Package sets are designed for 3/4" and 1-3/8" thick doors. For 1" to 1-1/8" thick doors, either all A or B carriers are required and may be ordered in the components section.

Hardware Contents	BYP-50S-2D-4	BYP-50S-2D-5	BYP-50S-2D-6	BYP-50S-2D-8	BYP-50S-3D-8
Track	3800-z47"	3800-z59"	3800-z71"	3800-z94"	3800-z94"
Single wheel carriers-0200-A	2	2	2	2	2
Single wheel carriers-0200-B	2	2	2	2	4
Door guide 0353	1	1	1	1	2
Finger pulls-0864-US15P	2	2	2	2	3
Door stop-0880	1	1	1	1	1
Screws	Yes	Yes	Yes	Yes	Yes

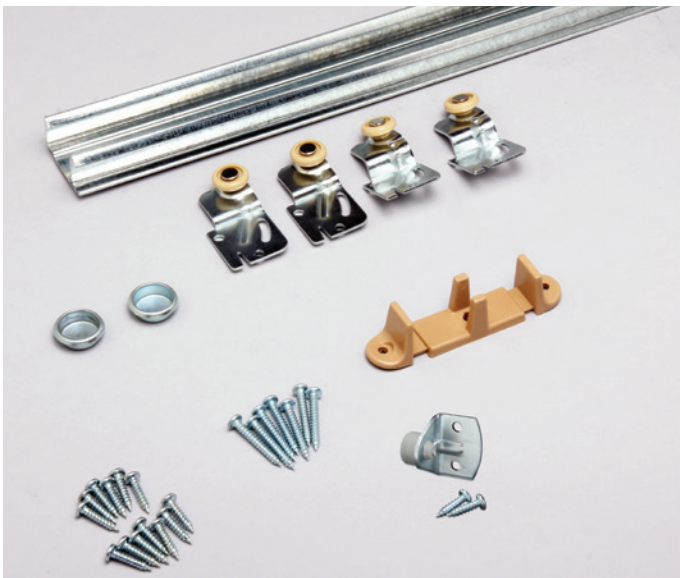

BYP-50S-2D

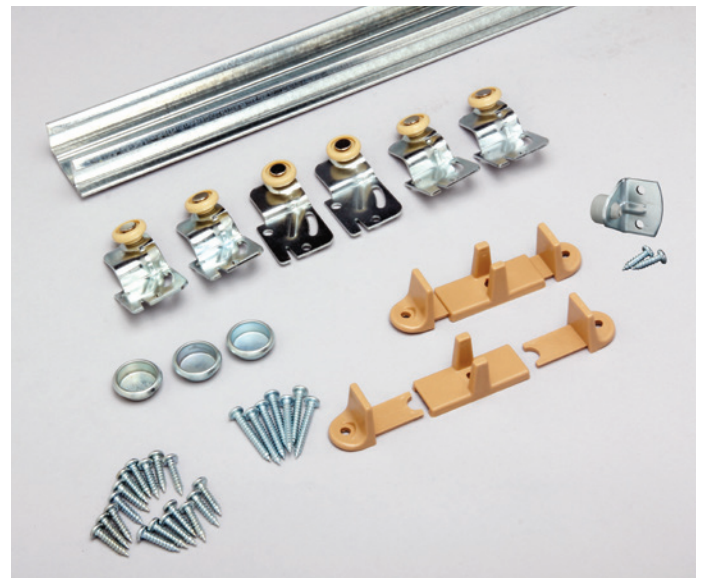

BYP-50S-3D

## Tracks

SKU	Description	Pack Qty	Pack Qty Weight (Lb)
BK-3800-Z47	47" Double-J zinc finished steel track	20	42
BK-3800-Z59	59" Double-J zinc finished steel track	20	52
BK-3800-Z71	71" Double-J zinc finished steel track	20	56
BK-3800-Z94	94" Double-J zinc finished steel track	10	41
BK-3800-Z120	120" Double-J zinc finished steel track	10	43



## Part Bags

SKU	Door Panels	Pack Qty	Pack Qty Weight (Lb)
PB-BYP-50-2	2	10	6
PB-BYP-50-3	3	10	9

Hardware Contents	PB-BYP-50-2	PB-BYP-50-3
Single wheel carrier 0200-A	2	2
Single wheel carrier 0200-B	2	4
Door guide-0353	1	2
Finger pulls-0864-US15	2	3
Door stop-0880	1	1
Screws	Yes	Yes

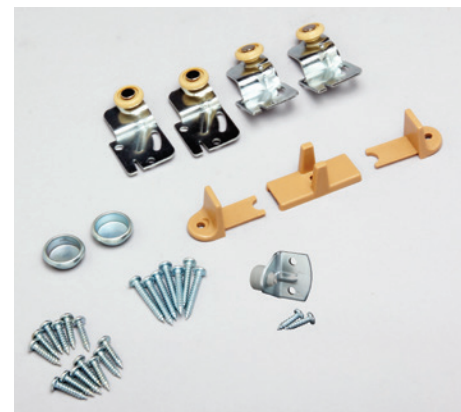

PB-BYP-50-2

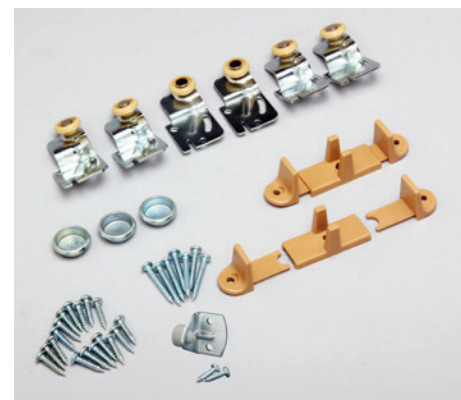

PB-BYP-50-3

# Components

SKU	Description	Pack Qty	Pack Qty Weight (Lb)
BK-0200-A	Single wheel carrier, A offset, 3/4" diameter wheel	100	8
BK-0200-B	Single wheel carrier, B offset, 3/4" diameter wheel	100	8
BK-0351	Non-adjustable door guide	50	3
BK-0351-WT	Non-adjustable door guide (white)	50	3
BK-0354	3/4" riser, fits 0351 and 0353	50	6
BK-0864-US3	3/4" finger pull (bright brass)	100	1
BK-0865-WT	1-3/4" finger pull (white)	100	2
BN-0353	Adjustable door guide, 3/4" to 1-3/8"	100	4
BN-0868-US10B	2-1/8" finger pull (oil rubbed bronze)	150	5
BN-0868-US15	2-1/8" finger pull (satin nickel)	150	5
BN-0868-US26	2-1/8" finger pull (bright chrome)	150	5
BN-0868-US3	2-1/8" finger pull (bright brass)	150	5
BN-0868-US5	2-1/8" finger pull (antique brass)	150	5
PB1068-26DA	Sliding door lock, nickel, keyed alike	5	2
PB1068-US26D	Sliding door lock, nickel, keyed different	5	2
PB1068-US3	Sliding door lock, brass, keyed different	5	2
PB1068-US3A	Sliding door lock, brass, keyed alike	5	2

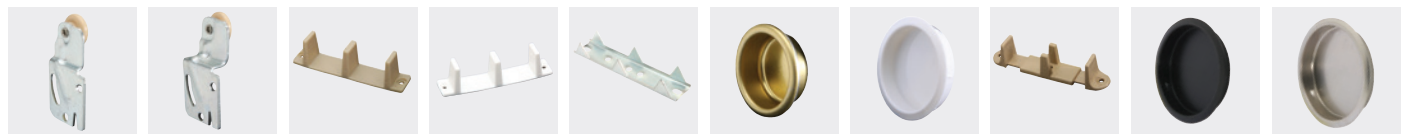

BK-0200-A BK-0200-B BK-0351 BK-0351-WT BK-0354 BK-0864-US3 BK-0865-WT BN-0353 BN-0868-US10B BN-0868-US15



BN-0868-US26 BN-0868-US3 BN-0868-US5 PB1068-26DA PB1068-US26D PB1068-US3 PB1068-US3A

# BYP-60S Series

## Steel track hardware for 60 lb by-pass doors.



Hardware for light to mid-weight two and three panel by-pass doors. The BYP-60S series is ideal for 60 lb by-pass doors used in residential closets, pantries, and room dividers.

Door thickness: 3/4" to 1-3/8"

Load rating: Up to 60 lbs per door

Track: Double-J steel track

Carrier: Twin wheel low friction bearing

Compares to: Hettich/Grant 6065, Johnson 1166, 1138, 113F, Stanley BP60

Conforms to: ANSI/BHMA A156.14-2007  
Grade 2, D8742

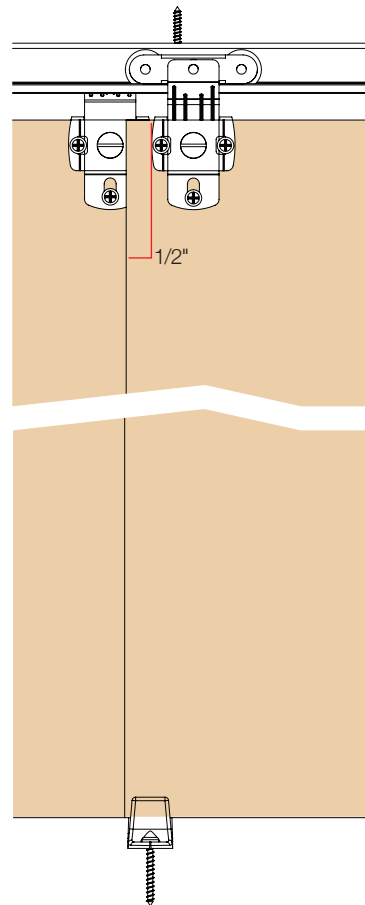
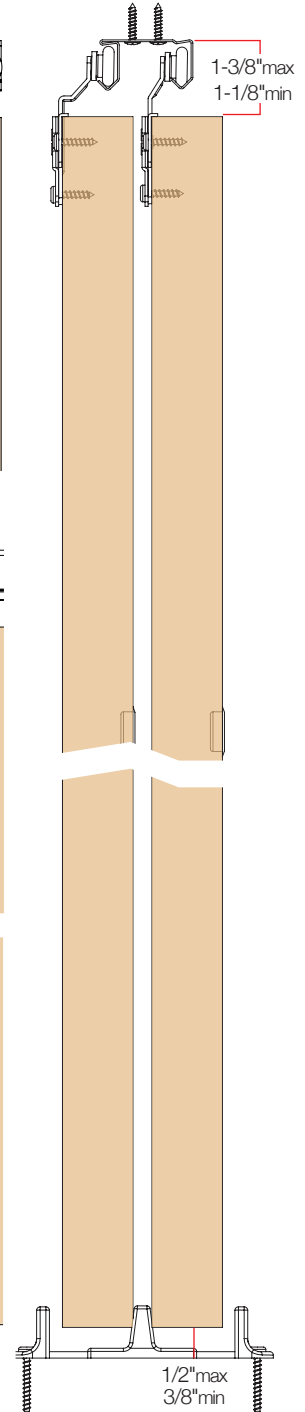
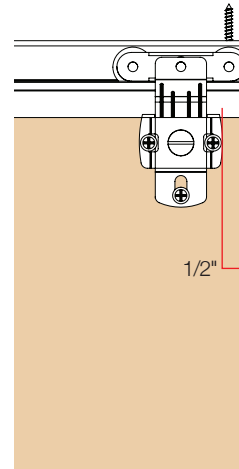

### BYP-60S series configuration

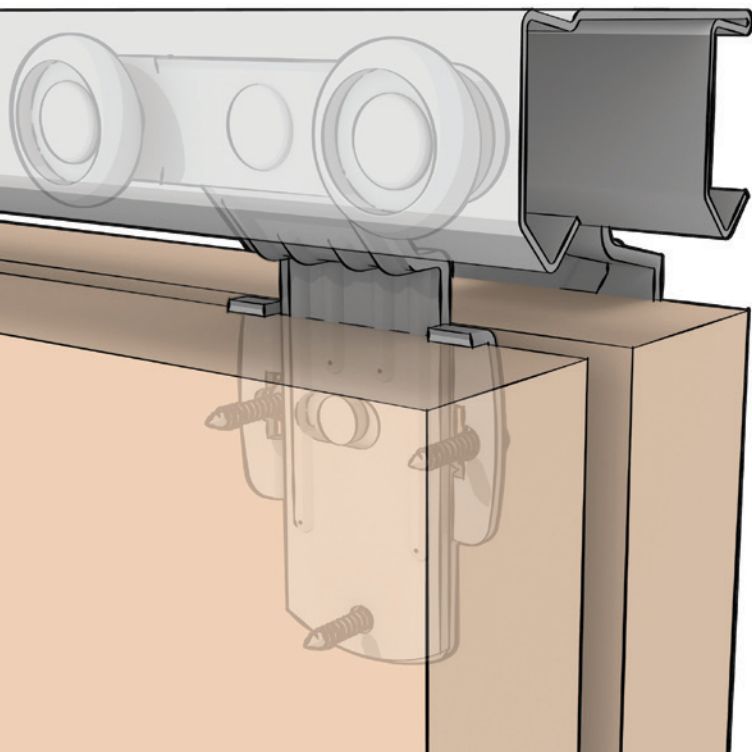

## Packaged Sets

SKU	Door Panel Configuration	Pack Qty	Pack Qty Weight (Lb)
BYP-60S-2D-4	2 x 24" doors	5	14
BYP-60S-2D-5	2 x 30" doors	5	16
BYP-60S-2D-6	2 x 36" doors	5	19
BYP-60S-2D-8	2 x 48" doors	5	22
BYP-60S-3D-8	3 x 32" doors	5	31

Note: Package sets are designed for 3/4" and 1-3/8" thick doors. For 1" to 1-1/8" thick doors, either all A or B carriers are required and may be ordered in the components section.

Hardware Contents	BYP-60S-2D-4	BYP-60S-2D-5	BYP-60S-2D-6	BYP-60S-2D-8	BYP-60S-3D-8
Track	3800-z47"	3800-z59"	3800-z71"	3800-z94"	3800-z94"
Twin wheel carriers-0400-ATW	2	2	2	2	2
Twin wheel carriers-0400-BTW	2	2	2	2	4
Door guide-0353	1	1	1	1	2
Finger pulls-0864-US15P	2	2	2	2	3
Door stop-0880	1	1	1	1	1
Screws	Yes	Yes	Yes	Yes	Yes

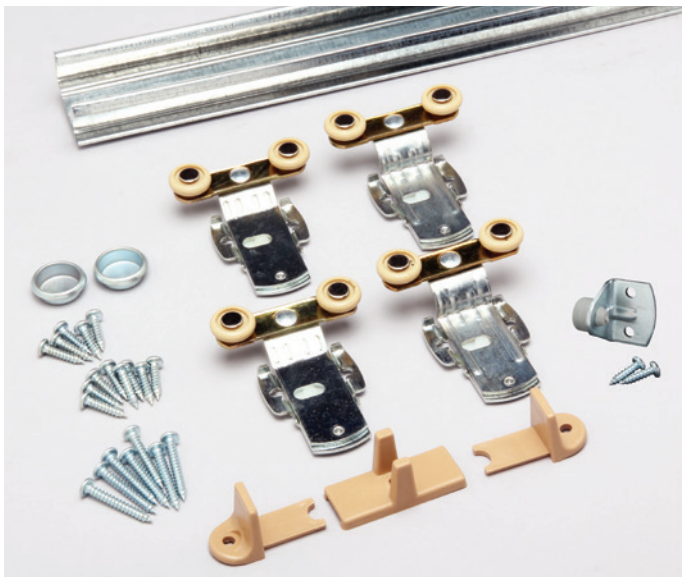

BYP-60S-2D



BYP-60S-3D

By-Pass Door Weight (Lb)

BYP-50S **BYP-60S** | 60A | 60AFR | 60AFS | 60AFS3 | 60SW | 60AFW | BYP-75AFW | 75S | 75A  
 BYP-100A | BYP-125A | BYP-150A | BYP-250A | BYP-175I | 275I | Components

## Tracks

SKU	Description	Pack Qty	Pack Qty Weight (Lb)
BK-3800-Z47	47" Double-J zinc finished steel track	20	42
BK-3800-Z59	59" Double-J zinc finished steel track	20	52
BK-3800-Z71	71" Double-J zinc finished steel track	20	56
BK-3800-Z94	94" Double-J zinc finished steel track	10	41
BK-3800-Z120	120" Double-J zinc finished steel track	10	43



## Part Bags

SKU	Door Panels	Pack Qty	Pack Qty Weight (Lb)
PB-BYP-60S-2	2	10	9
PB-BYP-60S-3	3	10	15

Hardware Contents	PB-BYP-60S-2	PB-BYP-60S-3
Twin wheel carrier 0400-ATW	2	2
Twin wheel carrier 0400-BTW	2	4
Door guide-0353	1	2
Finger pulls-0864-US15	2	3
Door stop-0880	1	1
Screws	Yes	Yes

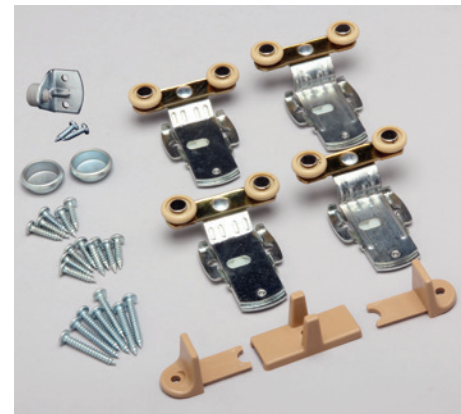

PB-BYP-60S-2



PB-BYP-60S-3

# Components

SKU	Description	Pack Qty	Pack Qty Weight (Lb)
BK-0351	Non-adjustable door guide	50	3
BK-0351-WT	Non-adjustable door guide (white)	50	3
BK-0354	3/4" riser, fits 0351 and 0353	50	6
BK-0864-US3	3/4" finger pull (bright brass)	100	1
BK-0865-WT	1-3/4" finger pull (white)	100	2
BN-0353	Adjustable door guide, 3/4" to 1-3/8"	100	4
BN-0868-US10B	2-1/8" finger pull (oil rubbed bronze)	150	5
BN-0868-US15	2-1/8" finger pull (satin nickel)	150	5
BN-0868-US26	2-1/8" finger pull (bright chrome)	150	5
BN-0868-US3	2-1/8" finger pull (bright brass)	150	5
BN-0868-US5	2-1/8" finger pull (antique brass)	150	5
PB-0400-ATW	Twin wheel carrier with dial adjustment, A offset, 3/4" diameter wheel	20	4
PB-0400-BTW	Twin wheel carrier with dial adjustment, B offset, 3/4" diameter wheel	20	4
PB1068-26DA	Sliding door lock, nickel, keyed alike	5	2
PB1068-US26D	Sliding door lock, nickel, keyed different	5	2
PB1068-US3	Sliding door lock, brass, keyed different	5	2
PB1068-US3A	Sliding door lock, brass, keyed alike	5	2



BK-0351 BK-0351-WT BK-0354 BK-0864-US3 BK-0865-WT BN-0353 BN-0868-US10B BN-0868-US15 BN-0868-US26 BN-0868-US3



BN-0868-US5 PB-0400-ATW PB-0400-BTW PB1068-26DA PB1068-US26D PB1068-US3 PB1068-US3A



# BYP-60A Series

## Aluminum track hardware for 60 lb by-pass doors.



Hardware for light to mid-weight two and three panel by-pass doors. The BYP-60A series is ideal for 60 lb by-pass doors used in residential closets, pantries, and room dividers.

Door thickness: 3/4" to 1-3/8"

Load rating: Up to 60 lbs per door

Track: Aluminum double-J track

Carrier: Single wheel low friction bearing

Compares to: Hettich/Grant 6065, Johnson 2222, Stanley BP60, BPD60, BP75-03

Conforms to: ANSI/BHMA A156.14-2007  
Grade 2, D8742

### BYP-60A series configuration

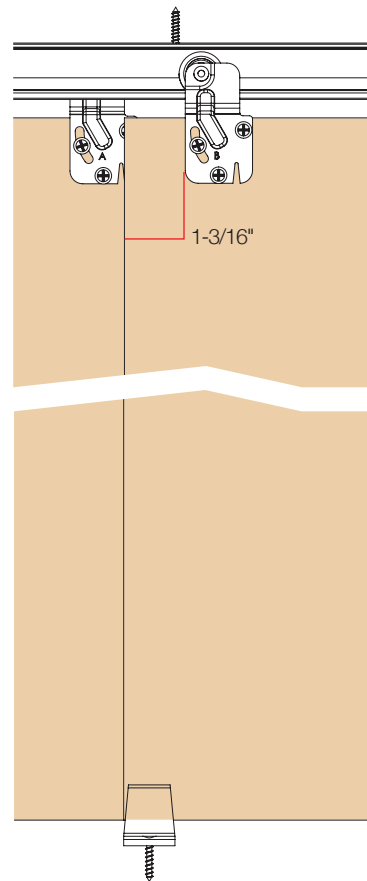
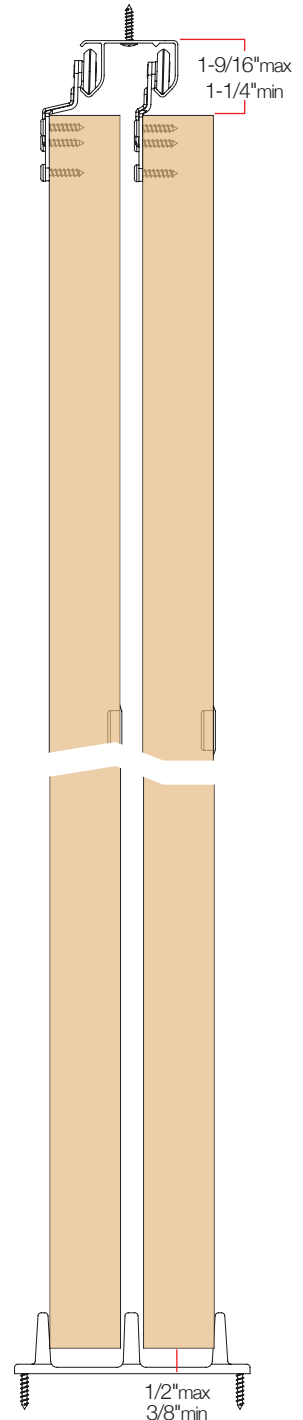
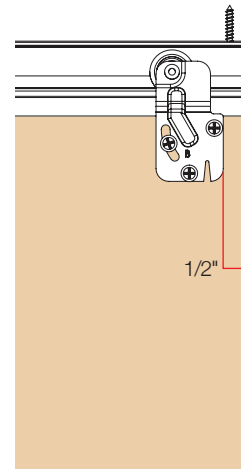
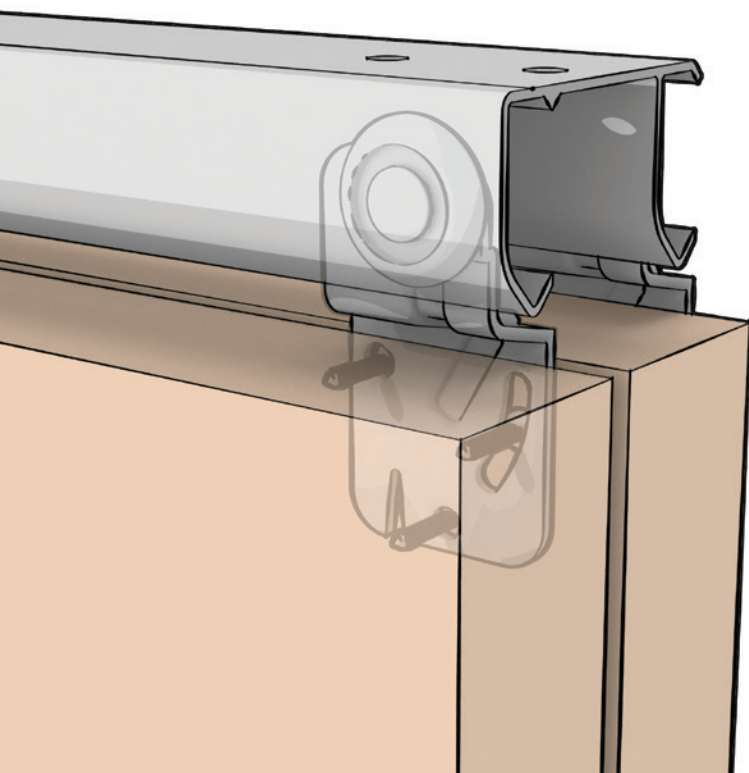

## Packaged Sets

SKU	Door Panel Configuration	Pack Qty	Pack Qty Weight (Lb)
BYP-60A-2D-4	2 x 24" doors	5	10
BYP-60A-2D-5	2 x 30" doors	5	12
BYP-60A-2D-6	2 x 36" doors	5	14
BYP-60A-2D-8	2 x 48" doors	5	17
BYP-60A-3D-8	3 x 32" doors	5	19

Note: Package sets are designed for 3/4" and 1-3/8" thick doors. For 1" to 1-1/8" thick doors, either all A or B carriers are required and may be ordered in the components section.

Hardware Contents	BYP-60A-2D-4	BYP-60A-2D-5	BYP-60A-2D-6	BYP-60A-2D-8	BYP-60A-3D-8
Track	7810-46"	7810-58"	7810-70"	7810-93"	7810-93"
Single wheel carriers-7200-A	2	2	2	2	2
Single wheel carriers-7200-B	2	2	2	2	4
Floor guide 0351-WT	1	1	1	1	2
Door stop-0880	1	1	1	1	1
Door pull-0865-WT	2	2	2	2	3
Screws	Yes	Yes	Yes	Yes	Yes



BYP-60A-2D

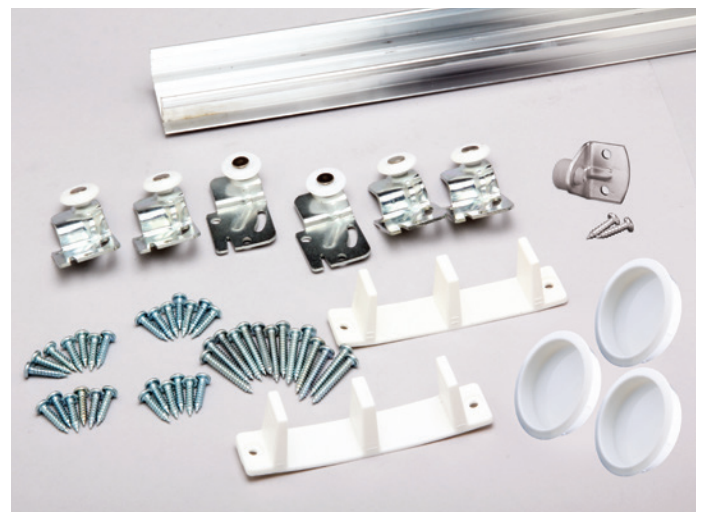

BYP-60A-3D

By-Pass Door Weight (Lb)

BYP-50S | **BYP-60S | 60A** | 60AFR | 60AFS | 60AFS3 | 60SW | 60AFW | BYP-75AFW | 75S | 75A  
 BYP-100A | BYP-125A | BYP-150A | BYP-250A | BYP-175I | 275I | Components

## Tracks

SKU	Description	Pack Qty	Pack Qty Weight (Lb)
BK-7810-46	46-3/8" Double-J aluminum track	10	11
BK-7810-58	58-3/8" Double-J aluminum track	10	14
BK-7810-70	70-3/8" Double-J aluminum track	10	17
BK-7810-93	93-3/8" Double-J aluminum track	10	22
BK-7810-120	120" Double-J aluminum track	10	39
BK-7810-144	144" Double-J aluminum track	10	47



## Part Bags

SKU	Door Panels	Pack Qty	Pack Qty Weight (Lb)
PB-BYP-60A-2	2	10	6
PB-BYP-60A-3	3	10	9

Hardware Contents	PB-BYP-60A-2	PB-BYP-60A-3
Single wheel carrier-7200-A	2	2
Single wheel carrier-7200-B	2	4
Floor guide -0351-WT	1	2
Door stop-0880	1	1
Door pull-0865-WT	2	3
Screws	Yes	Yes

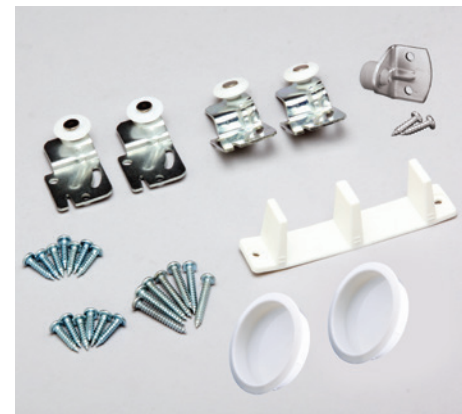

PB-BYP-60A-2

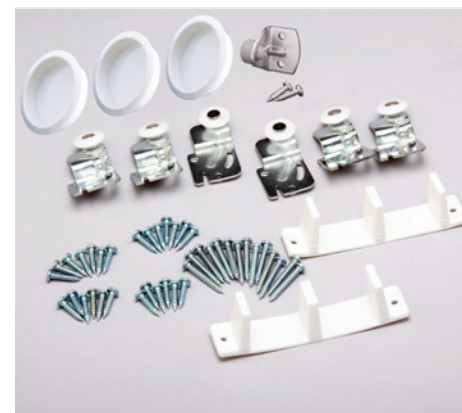

PB-BYP-60A-3

# Components

SKU	Description	Pack Qty	Pack Qty Weight (Lb)
BK-0351	Non-adjustable door guide	50	3
BK-0351-WT	Non-adjustable door guide (white)	50	3
BK-0354	3/4" riser, fits 0351 and 0353	50	6
BK-0864-US3	3/4" finger pull (bright brass)	100	1
BK-0865-WT	1-3/4" finger pull (white)	100	2
BK-7200-A	Single wheel carrier, offset A, 7/8" diameter wheel	100	10
BK-7200-ATW	Twin wheel carrier, offset A, 7/8" diameter wheels	100	14
BK-7200-B	Single wheel carrier, offset B, 7/8" diameter wheel	100	10
BK-7200-BTW	Twin wheel carrier, offset B, 7/8" diameter wheels	100	14
BK-7400-A	Single wheel carrier with adjustable dial, offset A, 7/8" diameter wheel	100	12
BK-7400-B	Single wheel carrier with adjustable dial, offset B, 7/8" diameter wheel	100	12
BN-0353	Adjustable door guide, 3/4" to 1-3/8"	100	4
BN-0868-US10B	2-1/8" finger pull (oil rubbed bronze)	150	5
BN-0868-US15	2-1/8" finger pull (satin nickel)	150	5
BN-0868-US26	2-1/8" finger pull (bright chrome)	150	5
BN-0868-US3	2-1/8" finger pull (bright brass)	150	5
BN-0868-US5	2-1/8" finger pull (antique brass)	150	5
BN-0880	Angle door stop	100	6
PB1068-26DA	Sliding door lock, nickel, keyed alike	5	2
PB1068-US26D	Sliding door lock, nickel, keyed different	5	2
PB1068-US3	Sliding door lock, brass, keyed different	5	2
PB1068-US3A	Sliding door lock, brass, keyed alike	5	2



# BYP-60AFR Series

## Aluminum ribbed fascia hardware for 60 lb by-pass doors.



Hardware for light to mid-weight two and three panel by-pass doors. The BYP-60AFR series features a 1-3/4" ribbed fascia and single wheel carriers for smooth door movement. Ideal for 60 lb by-pass doors used in residential closets, pantries, and room dividers.

- Door thickness: 1-3/8"
- Load rating: Up to 60 lbs per door
- Track: Double J aluminum track with 1-3/4" ribbed fascia
- Carrier: Single wheel low friction bearing
- Compares to: Hettich/Grant 6075, Johnson 2200F, 2204F, Stanley BP75-06
- Conforms to: ANSI/BHMA A156.14-2007 Grade 2, D8752

### BYP-60AFR series configuration

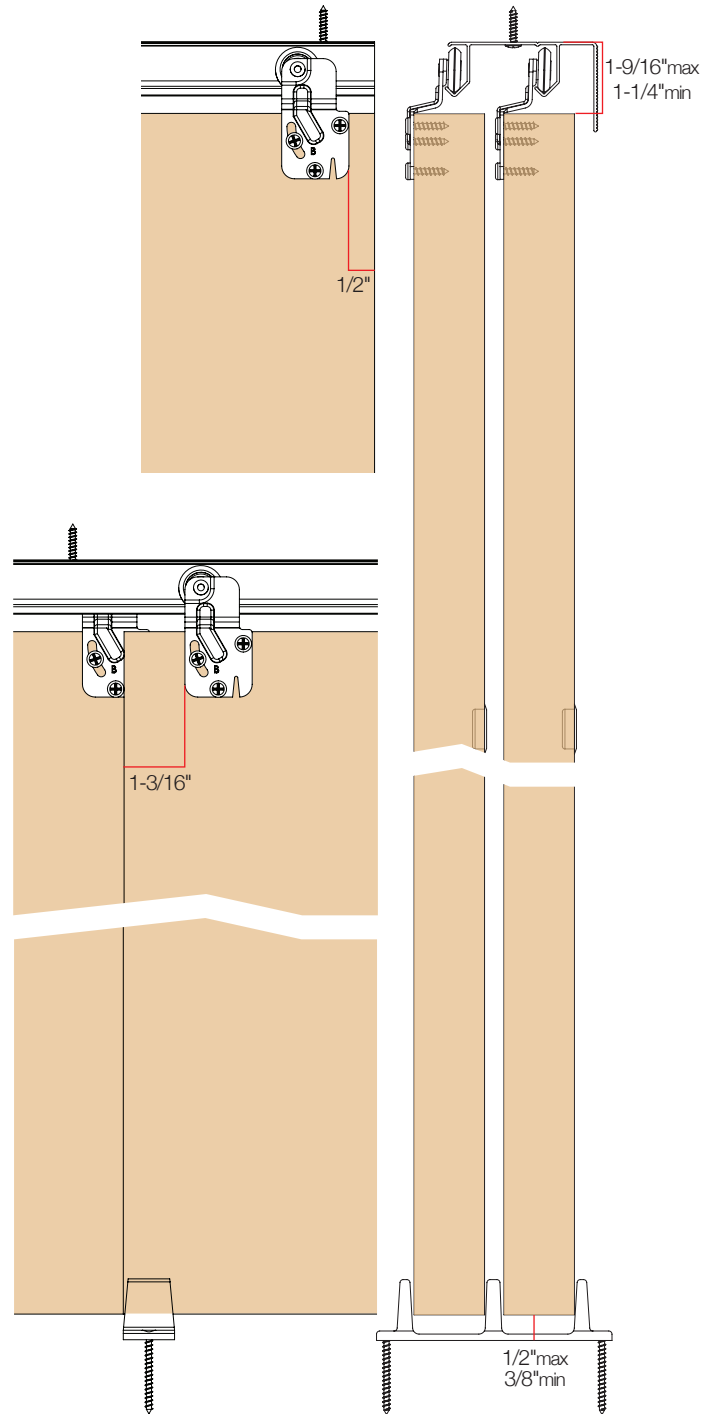
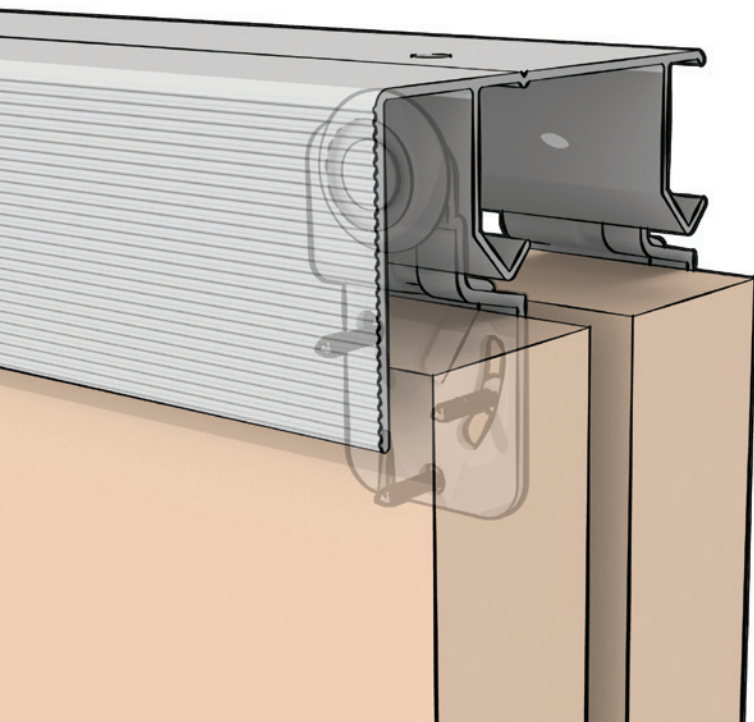

## Packaged Sets

SKU	Door Panel Configuration	Pack Qty	Pack Qty Weight (Lb)
BYP-60AFR-2D-4	2 x 24" doors	5	16
BYP-60AFR-2D-5	2 x 30" doors	5	19
BYP-60AFR-2D-6	2 x 36" doors	5	22
BYP-60AFR-2D-8	2 x 48" doors	5	26
BYP-60AFR-3D-8	3 x 32" doors	5	36

Hardware Contents	BYP-60AFR-2D-4	BYP-60AFR-2D-5	BYP-60AFR-2D-6	BYP-60AFR-2D-8	BYP-60AFR-3D-8
Track	7820-48"R	7820-60"R	7820-72"R	7820-96"R	7820-96"R
Single wheel carriers-7200-B	4	4	4	4	6
Flush pulls-0865-WT	2	2	2	2	3
Floor guide-0351	1	1	1	1	2
Door stop-0880	1	1	1	1	1
Screws	Yes	Yes	Yes	Yes	Yes

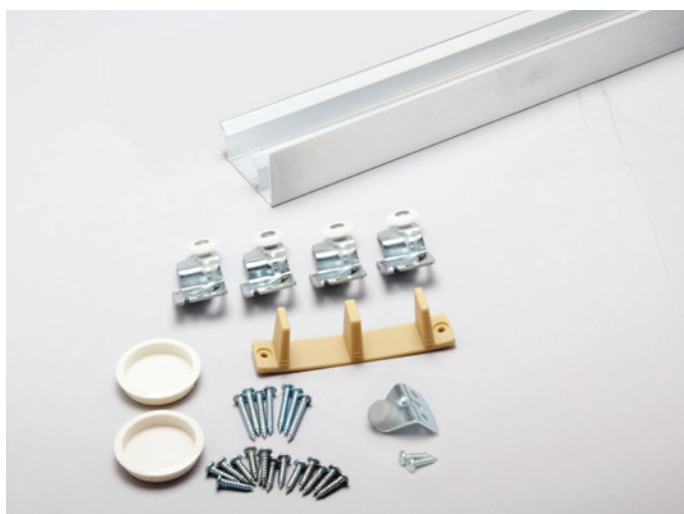

BYP-60AFR-2D

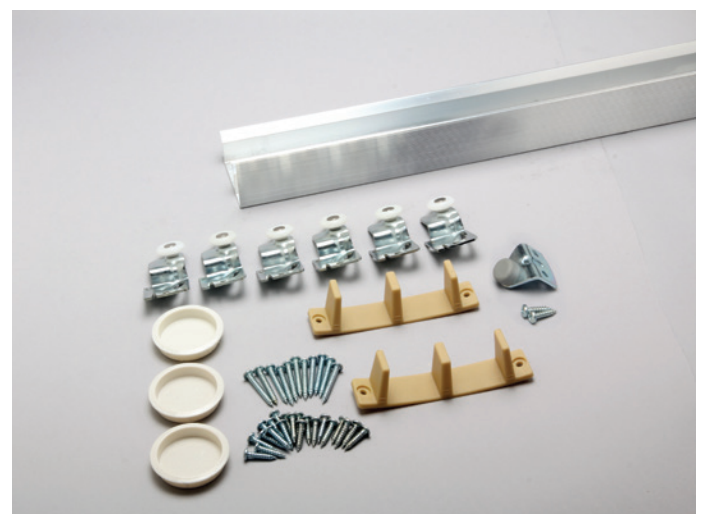

BYP-60AFR-3D

By-Pass Door Weight (Lb)

BYP-50S    **BYP-60S** | 60A | **60AFR** | 60AFS | 60AFS3 | 60SW | 60AFW    BYP-75AFW | 75S | 75A  
 BYP-100A    BYP-125A    BYP-150A    BYP-250A    BYP-175I | 275I    Components

## Tracks

SKU	Description	Pack Qty	Pack Qty Weight (Lb)
BK-7820-48R	48" x 1-3/4" Aluminum fascia ribbed track	5	15
BK-7820-60R	60" x 1-3/4" Aluminum fascia ribbed track	5	20
BK-7820-72R	72" x 1-3/4" Aluminum fascia ribbed track	5	25
BK-7820-96R	96" x 1-3/4" Aluminum fascia ribbed track	5	31
BK-7820-120R	120" x 1-3/4" Aluminum fascia ribbed track	5	33
BK-7820-144R	144" x 1-3/4" Aluminum fascia ribbed track	5	80



## Part Bags

SKU	Door Panels	Pack Qty	Pack Qty Weight (Lb)
PB-BYP-60AF-2	2	10	6
PB-BYP-60AF-3	3	10	9

Hardware Contents	PB-BYP-60AF-2	PB-BYP-60AF-3
1-3/4" white flush pull-0865-WT	2	3
Floor guide-0351	1	2
Single wheel carrier-7200-B	4	6
Door stop-0880	1	1
Screws	Yes	Yes

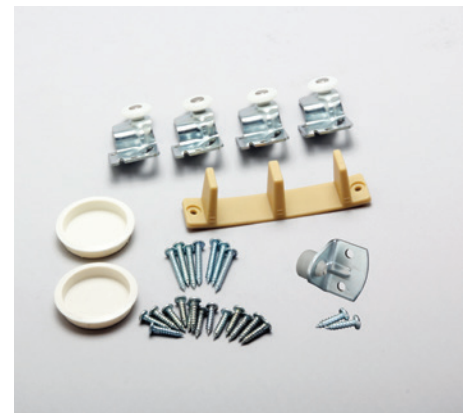

PB-BYP-60AF-2

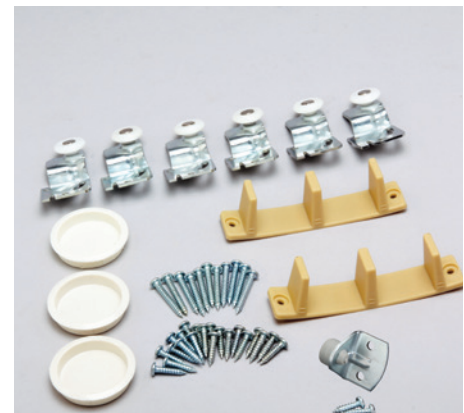

PB-BYP-60AF-3

# Components

SKU	Description	Pack Qty	Pack Qty Weight (Lb)
BK-0351	Non-adjustable door guide	50	3
BK-0351-WT	Non-adjustable door guide (white)	50	3
BK-0354	3/4" riser, fits 0351 and 0353	50	6
BK-0864-US3	3/4" finger pull (bright brass)	100	1
BK-0865-WT	1-3/4" finger pull (white)	100	2
BK-7200-B	Single wheel carrier, offset B, 7/8" diameter wheel	100	10
BK-7200-BTW	Twin wheel carrier, offset B, 7/8" diameter wheels	100	14
BK-7400-B	Single wheel carrier with adjustable dial, offset B, 7/8" diameter wheel	100	12
BN-0353	Adjustable door guide, 3/4" to 1-3/8"	100	4
BN-0868-US10B	2-1/8" finger pull (oil rubbed bronze)	150	5
BN-0868-US15	2-1/8" finger pull (satin nickel)	150	5
BN-0868-US26	2-1/8" finger pull (bright chrome)	150	5
BN-0868-US3	2-1/8" finger pull (bright brass)	150	5
BN-0868-US5	2-1/8" finger pull (antique brass)	150	5
BN-0880	Angle door stop	100	6
PB1068-26DA	Sliding door lock, nickel, keyed alike	5	2
PB1068-US26D	Sliding door lock, nickel, keyed different	5	2
PB1068-US3	Sliding door lock, brass, keyed different	5	2
PB1068-US3A	Sliding door lock, brass, keyed alike	5	2



BK-0351 BK-0351-WT BK-0354 BK-0864-US3 BK-0865-WT BK-7200-B BK-7200-BTW BK-7400-B BN-0353



BN-0868-US10B BN-0868-US15 BN-0868-US26 BN-0868-US3 BN-0868-US5 BN-0880 PB1068-26DA PB1068-US26D PB1068-US3 PB1068-US3A



# BYP-60AFS Series

## Aluminum smooth fascia hardware for 60 lb by-pass doors.



Hardware for light to mid-weight two and three panel by-pass doors. The BYP-60AFS series features a 1-3/4" smooth fascia and single wheel carriers for smooth door movement. Ideal for 60 lb by-pass doors in residential closets, pantries, and room dividers.

Door thickness: 1-3/8"

Load rating: Up to 60 lbs per door

Track: Double-J aluminum track with 1-3/4" smooth fascia

Carrier: Single wheel low friction bearing

Compares to: Hettich/Grant 6065, Johnson 2200F, Stanley BP75-06

Conforms to: ANSI/BHMA A156.14-2007  
Grade 2, D8752

### BYP-60AFS series configuration

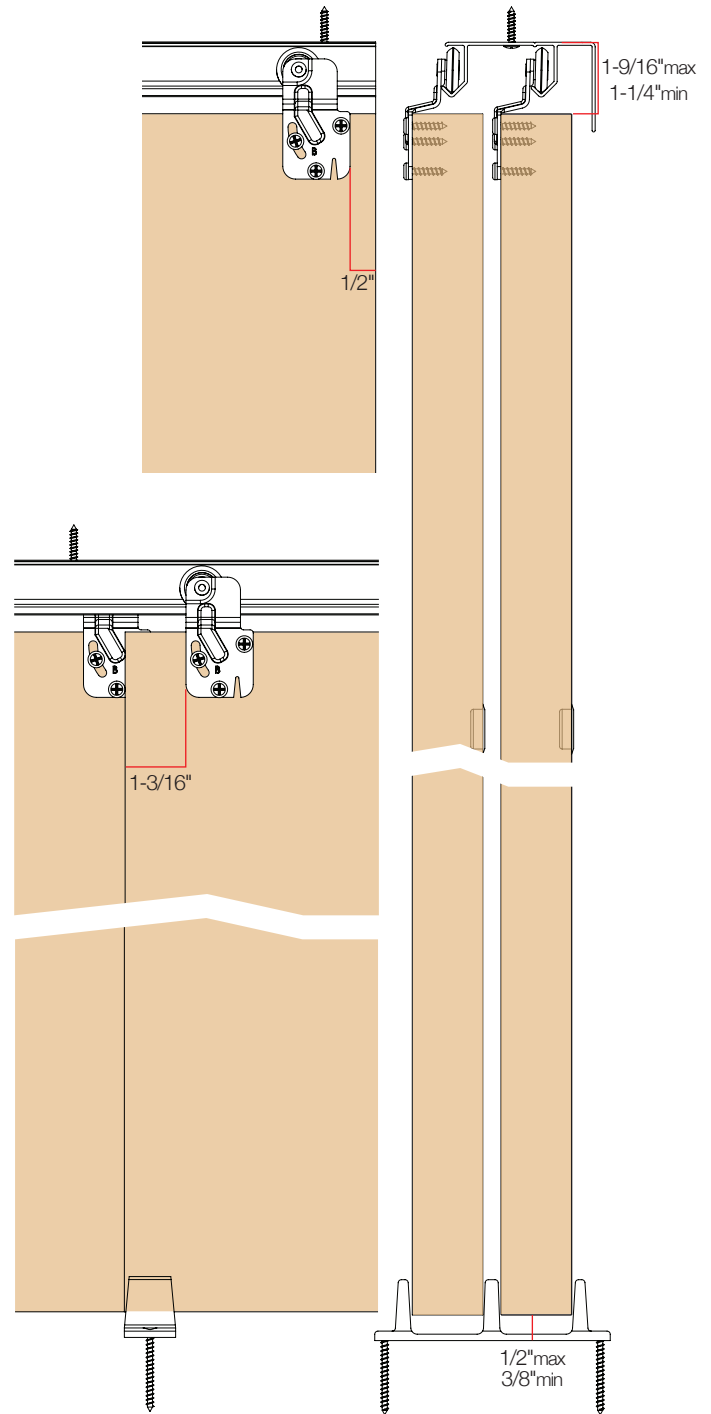
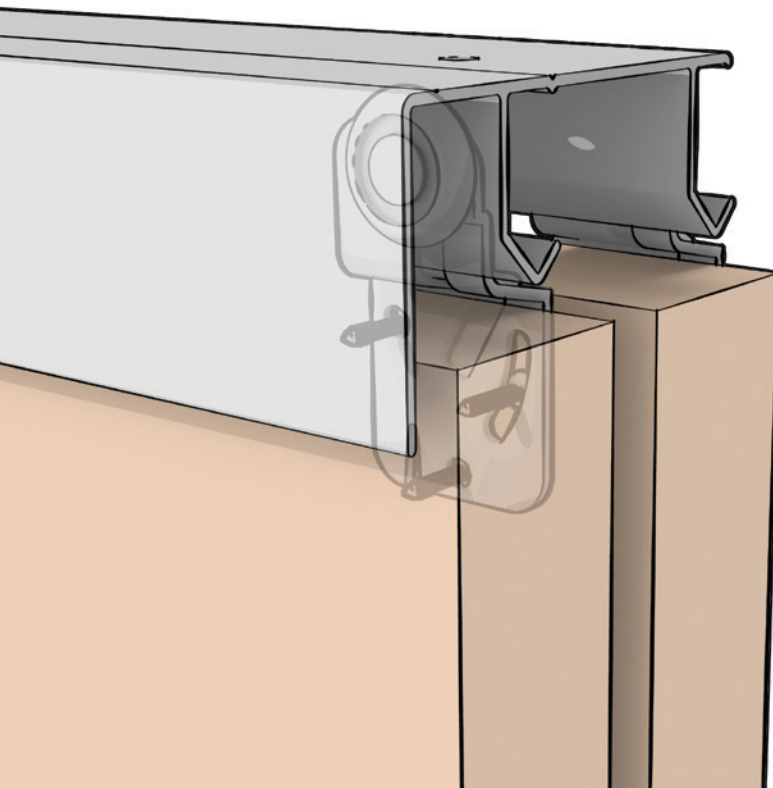

## Packaged Sets

SKU	Door Panel Configuration	Pack Qty	Pack Qty Weight (Lb)
BYP-60AFS-2D-4	2 x 24" doors	5	16
BYP-60AFS-2D-5	2 x 30" doors	5	19
BYP-60AFS-2D-6	2 x 36" doors	5	22
BYP-60AFS-2D-8	2 x 48" doors	5	26
BYP-60AFS-3D-8	3 x 32" doors	5	36

Hardware Contents	BYP-60AFS-2D-4	BYP-60AFS-2D-5	BYP-60AFS-2D-6	BYP-60AFS-2D-8	BYP-60AFS-3D-8
Track	7820-48"	7820-60"	7820-72"	7820-96"	7820-96"
Single wheel carriers-7200-B	4	4	4	4	6
Flush pulls-0865-WT	2	2	2	2	3
Floor guide-0351	1	1	1	1	2
Door stop-0880	1	1	1	1	1
Screws	Yes	Yes	Yes	Yes	Yes



BYP-60AFS-2D

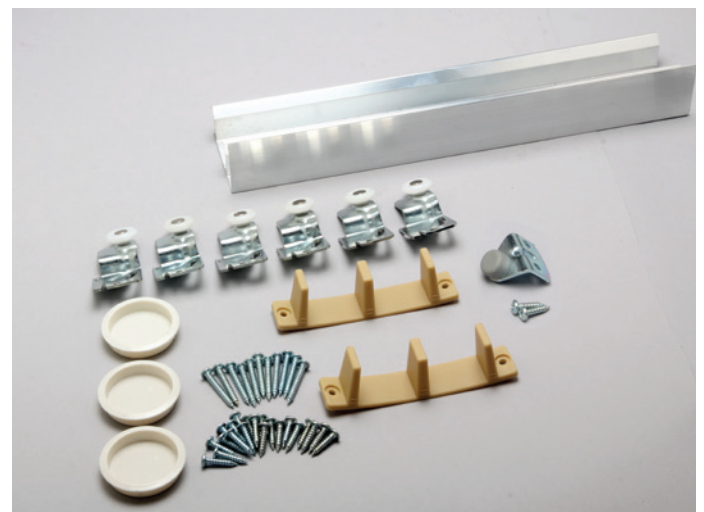

BYP-60AFS-3D

## Tracks

SKU	Description	Pack Qty	Pack Qty Weight (Lb)
BK-7820-48	48" x 1-3/4" Aluminum fascia smooth track	5	10
BK-7820-60	60" x 1-3/4" Aluminum fascia smooth track	5	12
BK-7820-72	72" x 1-3/4" Aluminum fascia smooth track	5	15
BK-7820-96	96" x 1-3/4" Aluminum fascia smooth track	5	20
BK-7820-120	120" x 1-3/4" Aluminum fascia smooth track	5	24
BK-7820-144	144" x 1-3/4" Aluminum fascia smooth track	10	58



## Part Bags

SKU	Door Panels	Pack Qty	Pack Qty Weight (Lb)
PB-BYP-60AF-2	2	10	6
PB-BYP-60AF-3	3	10	9

Hardware Contents	PB-BYP-60AF-2	PB-BYP-60AF-3
1-3/4" white flush pull-0865-WT	2	3
Floor guide-0351	1	2
Single wheel carrier-7200-B	4	6
Door stop-0880	1	1
Screws	Yes	Yes



PB-BYP-60AF-2

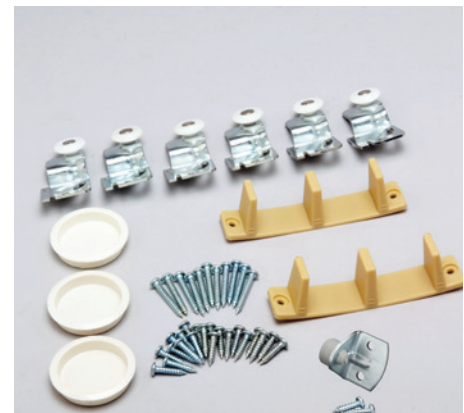

PB-BYP-60AF-3

# Components

SKU	Description	Pack Qty	Pack Qty Weight (Lb)
BK-0351	Non-adjustable door guide	50	3
BK-0351-WT	Non-adjustable door guide (white)	50	3
BK-0354	3/4" riser, fits 0351 and 0353	50	6
BK-0864-US3	3/4" finger pull (bright brass)	100	1
BK-0865-WT	1-3/4" finger pull (white)	100	2
BK-7200-B	Single wheel carrier, offset B, 7/8" diameter wheel	100	10
BK-7200-BTW	Twin wheel carrier, offset B, 7/8" diameter wheels	100	14
BK-7400-B	Single wheel carrier with adjustable dial, offset B, 7/8" diameter wheel	100	12
BN-0353	Adjustable door guide, 3/4" to 1-3/8"	100	4
BN-0868-US10B	2-1/8" finger pull (oil rubbed bronze)	150	5
BN-0868-US15	2-1/8" finger pull (satin nickel)	150	5
BN-0868-US26	2-1/8" finger pull (bright chrome)	150	5
BN-0868-US3	2-1/8" finger pull (bright brass)	150	5
BN-0868-US5	2-1/8" finger pull (antique brass)	150	5
BN-0880	Angle door stop	100	6
PB1068-26DA	Sliding door lock, nickel, keyed alike	5	2
PB1068-US26D	Sliding door lock, nickel, keyed different	5	2
PB1068-US3	Sliding door lock, brass, keyed different	5	2
PB1068-US3A	Sliding door lock, brass, keyed alike	5	2



# BYP-60AFS3 Series

## Aluminum 3" smooth fascia hardware for 60 lb by-pass doors.



Hardware for light to mid-weight two and three panel by-pass doors. The BYP-60AFS3 series features a 3" smooth fascia and single wheel carriers for smooth door movement. Ideal for 60 lb by-pass doors used in residential closets, pantries, and room dividers.

Door thickness: 1-3/8"

Load rating: Up to 60 lbs per door

Track: Double-J aluminum track with 3" smooth fascia

Carrier: Single wheel low friction bearing

Compares to: Hettich/Grant 6065, Johnson 2200F, Stanley BP75-05

Conforms to: ANSI/BHMA A156.14-2007 Grade 2, D8752

### BYP-60AFS3 series configuration

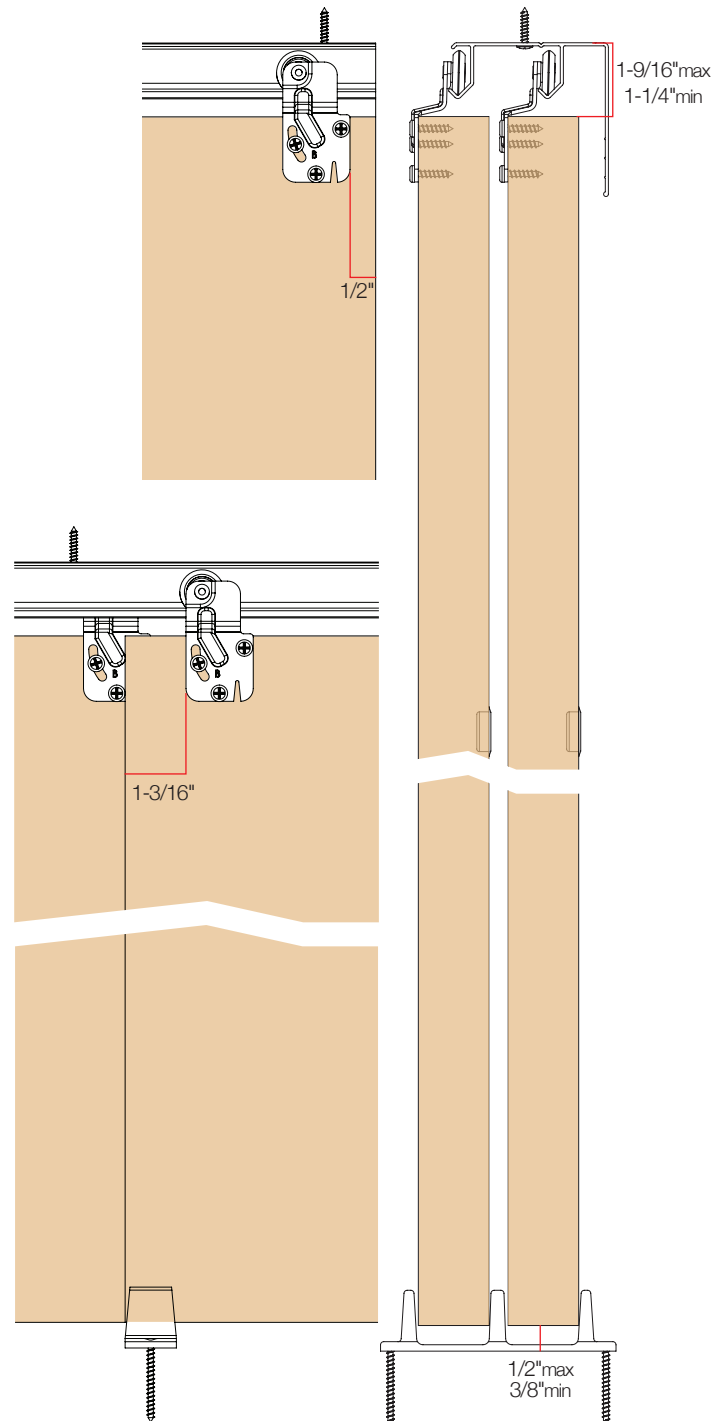
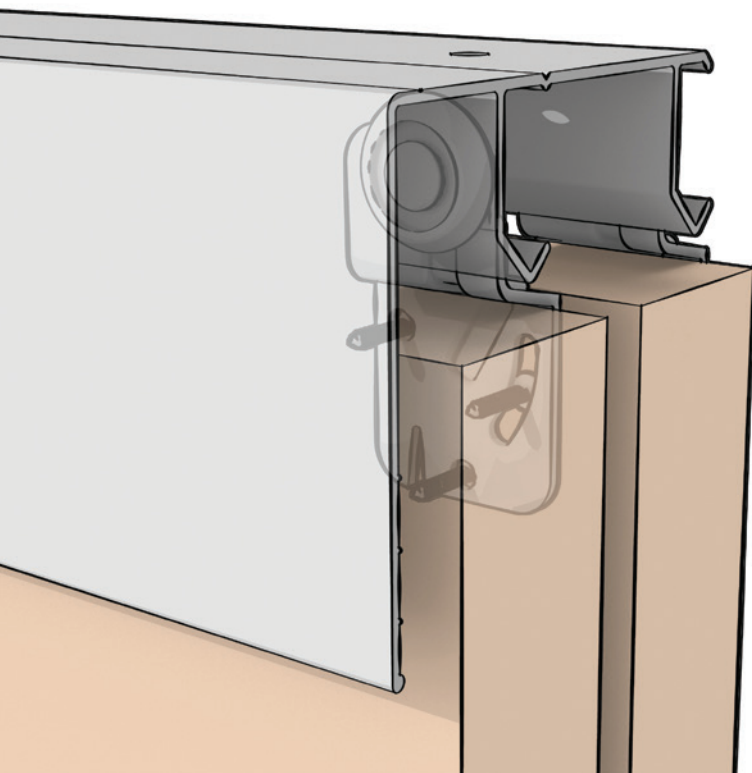

## Packaged Sets

SKU	Door Panel Configuration	Pack Qty	Pack Qty Weight (Lb)
BYP-60AFS3-2D-4	2 x 24" doors	5	18
BYP-60AFS3-2D-5	2 x 30" doors	5	23
BYP-60AFS3-2D-6	2 x 36" doors	5	28
BYP-60AFS3-2D-8	2 x 48" doors	5	34
BYP-60AFS3-3D-8	3 x 32" doors	5	49

Hardware Contents	BYP-60AFS3-2D-4	BYP-60AFS3-2D-5	BYP-60AFS3-2D-6	BYP-60AFS3-2D-8	BYP-60AFS3-3D-8
Track	7830-48"	7830-60"	7830-72"	7830-96"	7830-96"
Single wheel carriers-7200-B	4	4	4	4	6
Flush pulls-0865-WT	2	2	2	2	3
Floor guide-0351	1	1	1	1	2
Door stop-0880	1	1	1	1	1
Screws	Yes	Yes	Yes	Yes	Yes

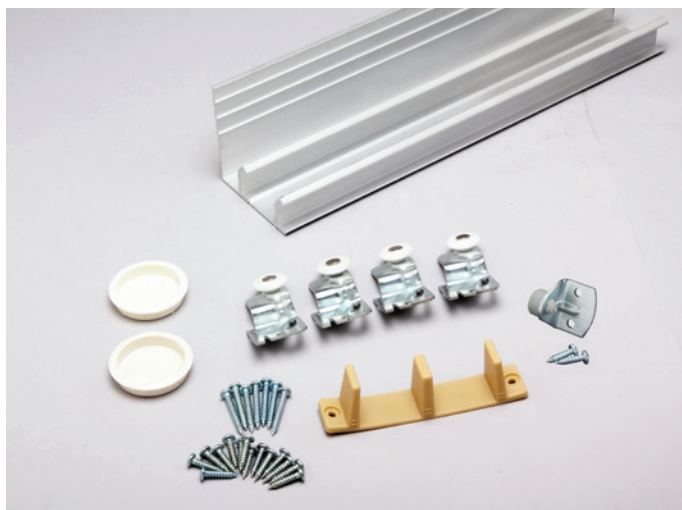

**BYP-60AFS3-2D**

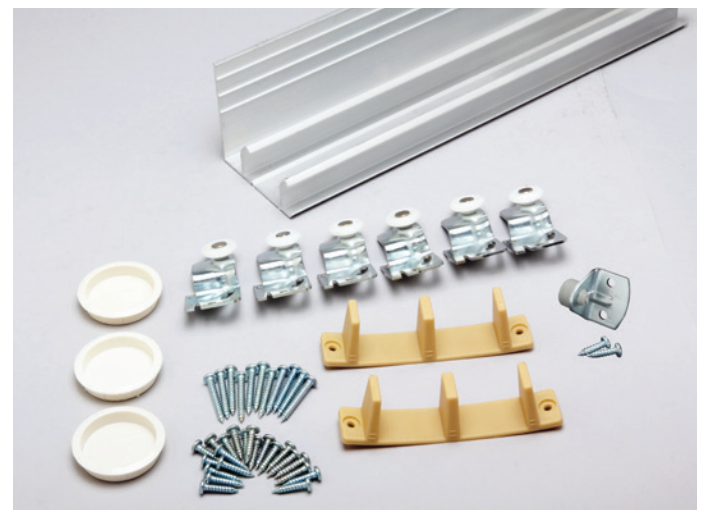

**BYP-60AFS3-3D**

## Tracks

SKU	Description	Pack Qty	Pack Qty Weight (Lb)
BK-7830-48	48" Aluminum 3" fascia smooth track	5	15
BK-7830-60	60" Aluminum 3" fascia smooth track	5	20
BK-7830-72	72" Aluminum 3" fascia smooth track	5	25
BK-7830-96	96" Aluminum 3" fascia smooth track	5	31
BK-7830-120	120" Aluminum 3" fascia smooth track	5	33
BK-7830-144	144" Aluminum 3" fascia smooth track	5	40

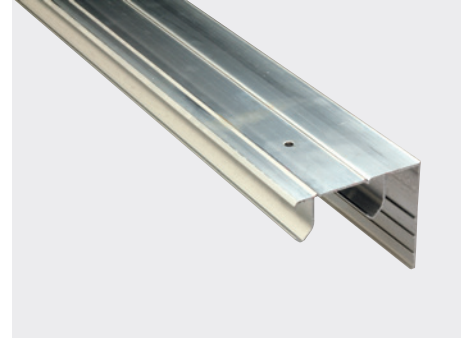

## Part Bags

SKU	Door Panels	Pack Qty	Pack Qty Weight (Lb)
PB-BYP-60AF-2	2	10	6
PB-BYP-60AF-3	3	10	9

Hardware Contents	PB-BYP-60AF-2	PB-BYP-60AF-3
1-3/4" white flush pull-0865-WT	2	3
Floor guide-0351	1	2
Single wheel carrier-7200-B	4	6
Door stop-0880	1	1
Screws	Yes	Yes

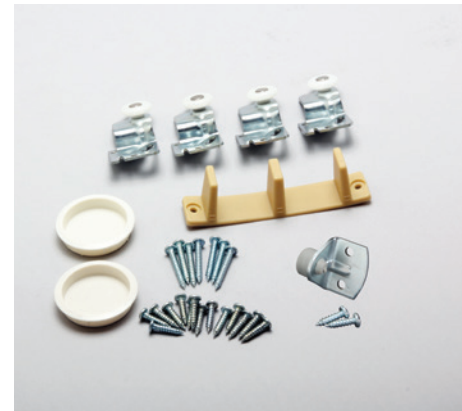

PB-BYP-60AF-2

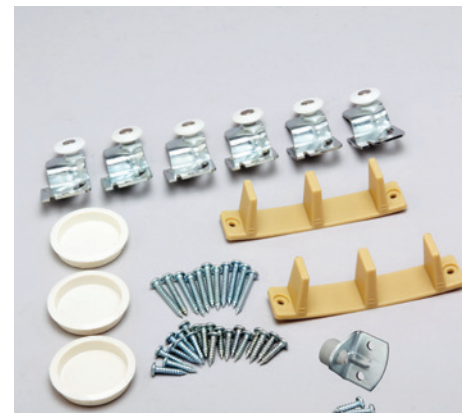

PB-BYP-60AF-3

# Components

SKU	Description	Pack Qty	Pack Qty Weight (Lb)
BK-0351	Non-adjustable door guide	50	3
BK-0351-WT	Non-adjustable door guide (white)	50	3
BK-0354	3/4" riser, fits 0351 and 0353	50	6
BK-0864-US3	3/4" finger pull (bright brass)	100	1
BK-0865-WT	1-3/4" finger pull (white)	100	2
BK-7200-B	Single wheel carrier, offset B, 7/8" diameter wheel	100	10
BK-7200-BTW	Twin wheel carrier, offset B, 7/8" diameter wheels	100	14
BK-7400-B	Single wheel carrier with adjustable dial, offset B, 7/8" diameter wheel	100	12
BN-0353	Adjustable door guide, 3/4" to 1-3/8"	100	4
BN-0868-US10B	2-1/8" finger pull (oil rubbed bronze)	150	5
BN-0868-US15	2-1/8" finger pull (satin nickel)	150	5
BN-0868-US26	2-1/8" finger pull (bright chrome)	150	5
BN-0868-US3	2-1/8" finger pull (bright brass)	150	5
BN-0868-US5	2-1/8" finger pull (antique brass)	150	5
BN-0880	Angle door stop	100	6
PB1068-26DA	Sliding door lock, nickel, keyed alike	5	2
PB1068-US26D	Sliding door lock, nickel, keyed different	5	2
PB1068-US3	Sliding door lock, brass, keyed different	5	2
PB1068-US3A	Sliding door lock, brass, keyed alike	5	2



Knape & Vogt® products follow the ANSI A156.14-2007 testing standards established by BHMA.





# BYP-60SW Series



## Steel wide track hardware for 60 lb by-pass doors.

Hardware for wide-track light to mid-weight two and three panel by-pass doors. The BYP-60SW series features an extra wide track for 1-3/4" thick doors and single wheel carriers for smooth door movement. The extra wide track is ideal for high-quality, thicker 60 lb by-pass doors used in residential custom closets, pantries, and room dividers.

Door thickness: 1-3/8" to 1-3/4"

Load rating: Up to 60 lbs per door

Track: Double-J steel track

Carrier: Single wheel low friction bearing

Compares to: Hettich/Grant 6065, Stanley PB75-01

Conforms to: ANSI/BHMA A156.14-2007  
Grade 2, D8742

### BYP-60SW series configuration

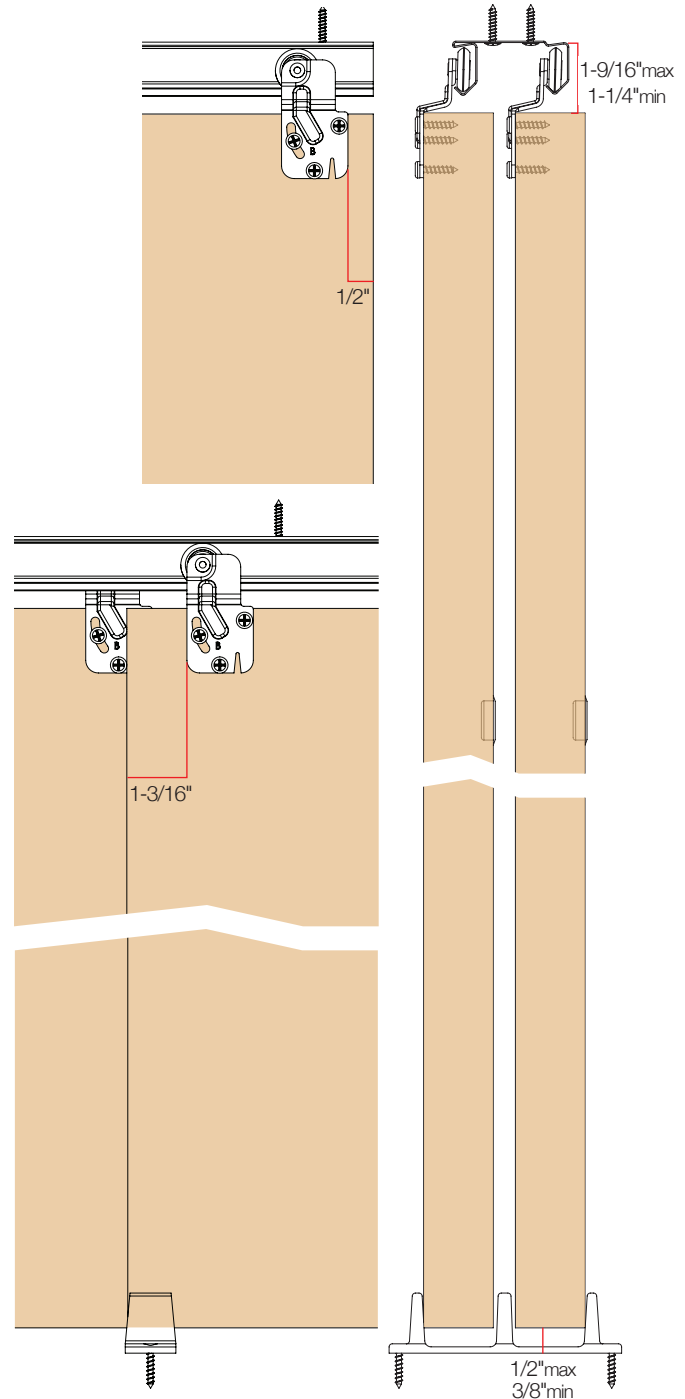
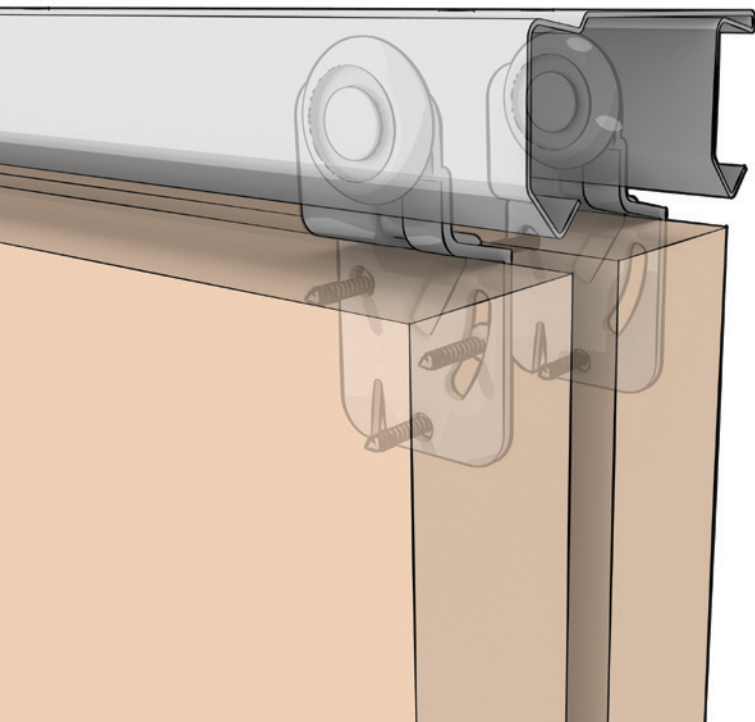

## Packaged Sets

SKU	Door Panel Configuration	Pack Qty	Pack Qty Weight (Lb)
BYP-60SW-2D-4	2 x 24" doors	5	13
BYP-60SW-2D-5	2 x 30" doors	5	16
BYP-60SW-2D-6	2 x 36" doors	5	18
BYP-60SW-2D-8	2 x 48" doors	5	20
BYP-60SW-3D-8	3 x 32" doors	5	26

Hardware Contents	BYP-60SW-2D-4	BYP-60SW-2D-5	BYP-60SW-2D-6	BYP-60SW-2D-8	BYP-60SW-3D-8
Track	7840-46"	7840-58"	7840-70"	7840-93"	7840-93"
Single wheel carriers-7200-B	4	4	4	4	6
Finger pulls-0864-US15P	2	2	2	2	3
Floor guide-0351	1	1	1	1	2
Door stop-0880	1	1	1	1	1
Screws	Yes	Yes	Yes	Yes	Yes

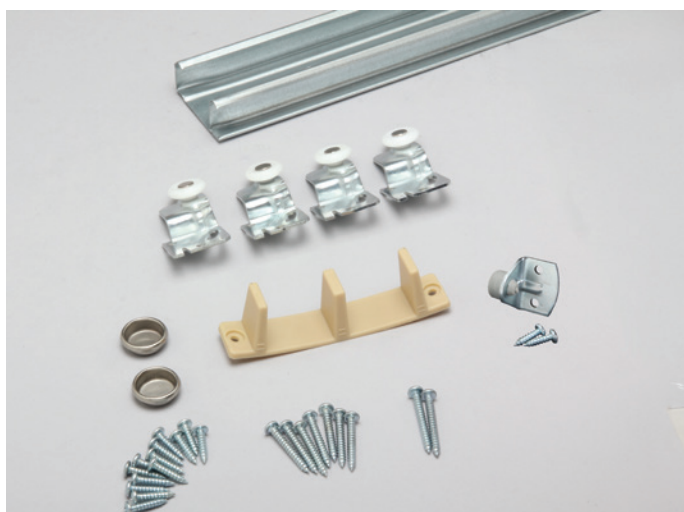

**BYP-60SW-2D**

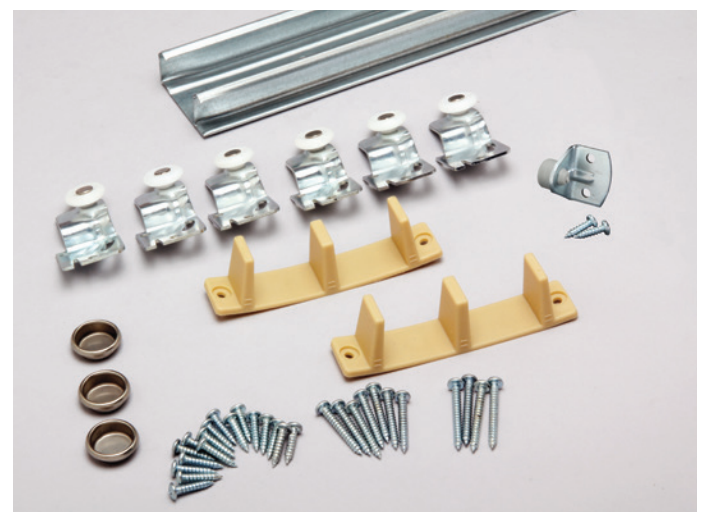

**BYP-60SW-3D**

By-Pass Door Weight (Lb)

BYP-50S    **BYP-60S** | 60A | 60AFR | 60AFS | 60AFS3 | **60SW** | 60AFW    BYP-75AFW | 75S | 75A  
 BYP-100A    BYP-125A    BYP-150A    BYP-250A    BYP-175I | 275I    Components

## Tracks

SKU	Description	Pack Qty	Pack Qty Weight (Lb)
BK-7840-46	46-1/2" Double-J steel wide track	10	21
BK-7840-58	58-1/2" Double-J steel wide track	10	26
BK-7840-70	70-1/2" Double-J steel wide track	10	31
BK-7840-81	81-1/2" Double-J steel wide track	5	17
BK-7840-93	93-1/2" Double-J steel wide track	5	21
BK-7840-120	120" Double-J steel wide track	5	25
BK-7840-144	144" Double-J steel wide track	5	30



## Part Bags

SKU	Door Panels	Pack Qty	Pack Qty Weight (Lb)
PB-BYP-60AF-2	2	10	6
PB-BYP-60AF-3	3	10	9

Hardware Contents	PB-BYP-60AF-2	PB-BYP-60AF-3
1-3/4" white flush pull-0865-WT	2	3
Floor guide-0351	1	2
Single wheel carrier-7200-B	4	6
Door stop-0880	1	1
Screws	Yes	Yes



PB-BYP-60AF-2

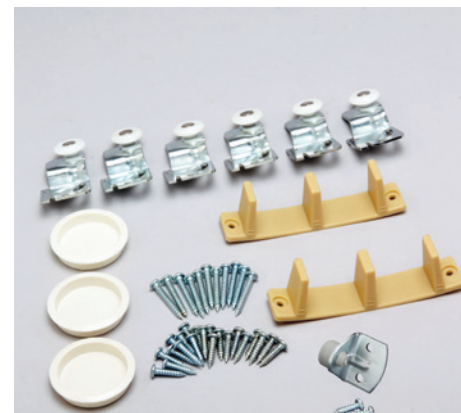

PB-BYP-60AF-3

# Components

SKU	Description	Pack Qty	Pack Qty Weight (Lb)
BK-0351	Non-adjustable door guide	50	3
BK-0351-WT	Non-adjustable door guide (white)	50	3
BK-0354	3/4" riser, fits 0351 and 0353	50	6
BK-0864-US3	3/4" finger pull (bright brass)	100	1
BK-0865-WT	1-3/4" finger pull (white)	100	2
BK-7200-A	Single wheel carrier, offset A, 7/8" diameter wheel	100	10
BK-7200-ATW	Twin wheel carrier, offset A, 7/8" diameter wheels	100	14
BK-7200-B	Single wheel carrier, offset B, 7/8" diameter wheel	100	10
BK-7200-BTW	Twin wheel carrier, offset B, 7/8" diameter wheels	100	14
BK-7400-B	Single wheel carrier with adjustable dial, offset B, 7/8" diameter wheel	100	12
BN-0353	Adjustable door guide, 3/4" to 1-3/8"	100	4
BN-0868-US10B	2-1/8" finger pull (oil rubbed bronze)	150	5
BN-0868-US15	2-1/8" finger pull (satin nickel)	150	5
BN-0868-US26	2-1/8" finger pull (bright chrome)	150	5
BN-0868-US3	2-1/8" finger pull (bright brass)	150	5
BN-0868-US5	2-1/8" finger pull (antique brass)	150	5
BN-0880	Angle door stop	100	6
PB1068-26DA	Sliding door lock, nickel, keyed alike	5	2
PB1068-US26D	Sliding door lock, nickel, keyed different	5	2
PB1068-US3	Sliding door lock, brass, keyed different	5	2
PB1068-US3A	Sliding door lock, brass, keyed alike	5	2



Knape & Vogt® products follow the ANSI A156.14-2007 testing standards established by BHMA.



# BYP-60AFW Series

## Aluminum wide fascia hardware for 60 lb by-pass doors.

Hardware for wide-track light to mid-weight two and three panel by-pass doors. The BYP-60AFW series features an extra wide track with 1-9/16" fascia and single wheel carriers for smooth door movement. The extra wide track and built in fascia is ideal for thicker 60 lb by-pass doors used in high-quality custom closets, pantries, and room dividers.

Door thickness:	1-3/8"
Load rating:	Up to 60 lbs per door
Track:	Double-J aluminum track with 1-9/16" smooth fascia
Carrier:	Single wheel low friction bearing
Compares to:	Hettich/Grant 6065, Johnson 2200F, Stanley BP75-03
Conforms to:	ANSI/BHMA A156.14-2007 Grade 2, D8752

### BYP-60AFW series configuration

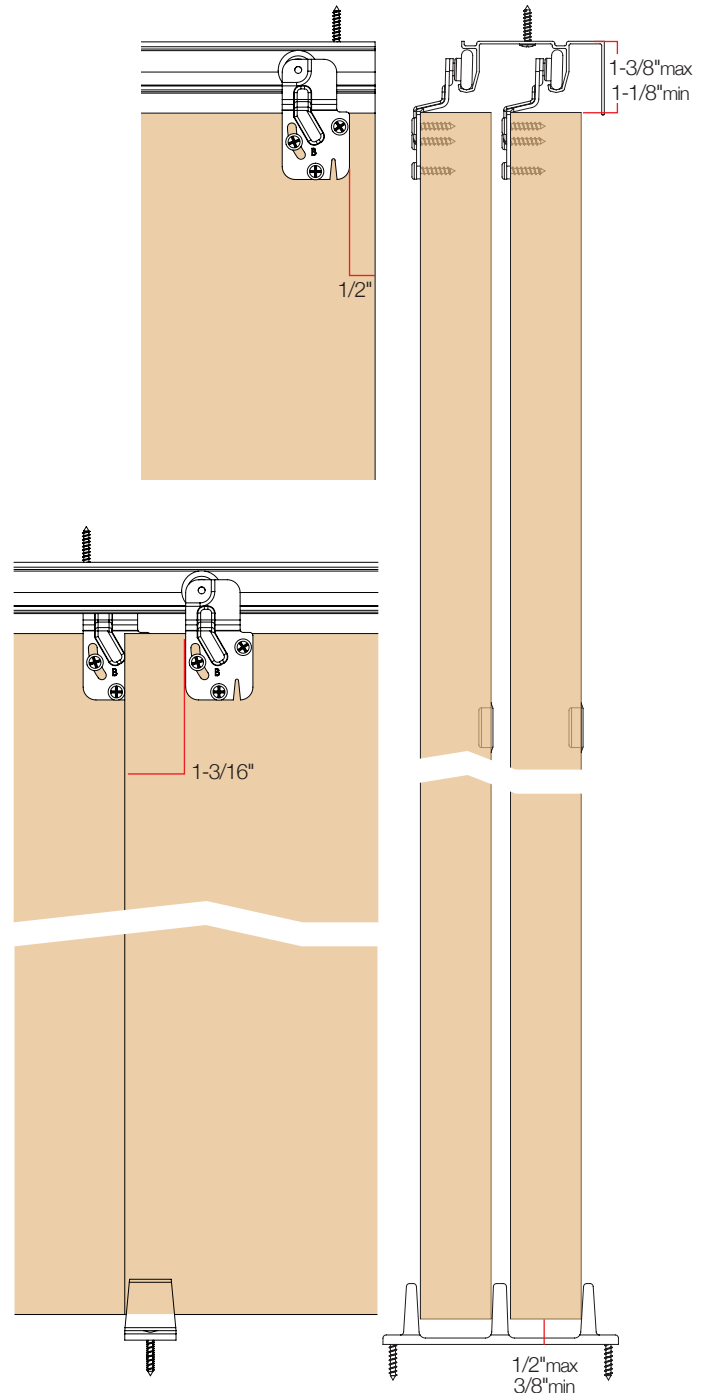
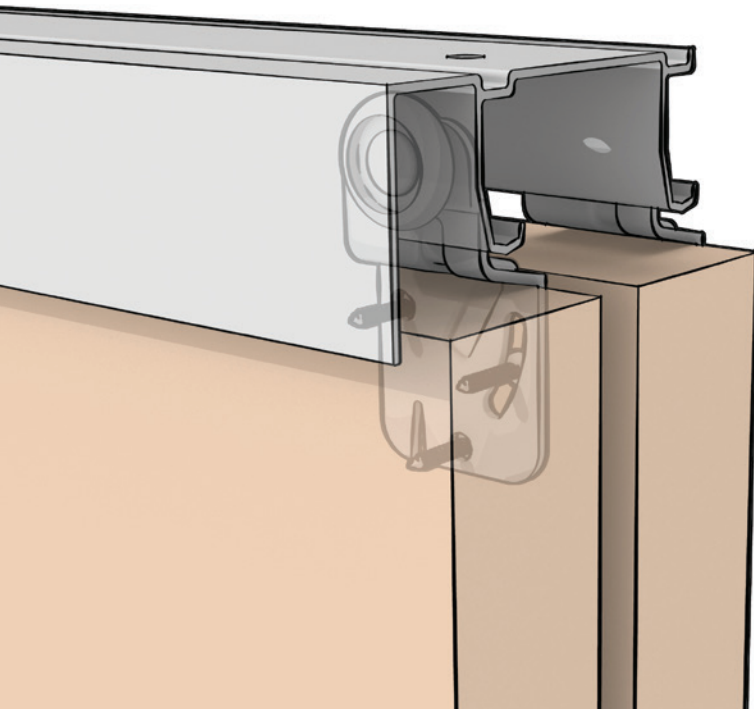

## Packaged Sets

SKU	Door Panel Configuration	Pack Qty	Pack Qty Weight (Lb)
BYP-60AFW-2D-4	2 x 24" doors	5	11
BYP-60AFW-2D-5	2 x 30" doors	5	13
BYP-60AFW-2D-6	2 x 36" doors	5	16
BYP-60AFW-2D-8	2 x 48" doors	5	19
BYP-60AFW-3D-8	2 x 32" doors	5	21

Hardware Contents	BYP-60AFW-2D-4	BYP-60AFW-2D-5	BYP-60AFW-2D-6	BYP-60AFW-2D-8	BYP-60AFW-3D-8
Track	5950-48"	5950-60"	5950-72"	5950-96"	5950-96"
Door stop-0880	1	1	1	1	1
Single wheel carriers-0200-B	4	4	4	4	6
Finger pulls-0868-US3	2	2	2	2	3
Floor guide-0351	1	1	1	1	2
Screws	Yes	Yes	Yes	Yes	Yes

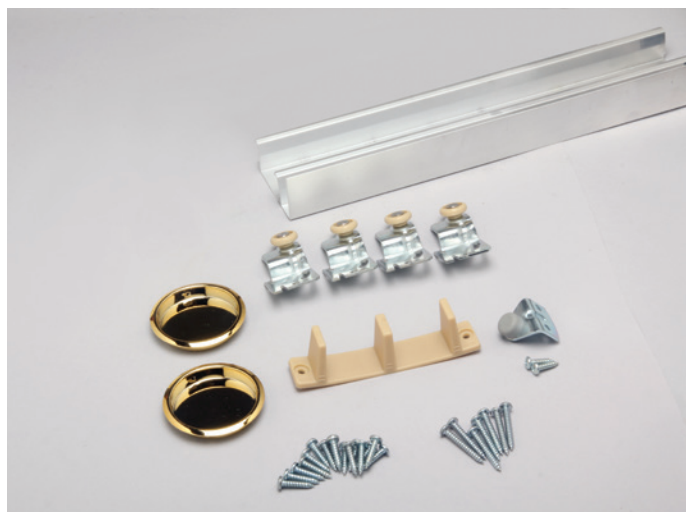

BYP-60AFW-2D



BYP-60AFW-3D

## Tracks

SKU	Description	Pack Qty	Pack Qty Weight (Lb)
BK-5950-48	48" Aluminum fascia with 1-9/16" wide track	10	18
BK-5950-60	60" Aluminum fascia with 1-9/16" wide track	10	24
BK-5950-72	72" Aluminum fascia with 1-9/16" wide track	10	28
BK-5950-96	96" Aluminum fascia with 1-9/16" wide track	10	36
BK-5950-120	120" Aluminum fascia with 1-9/16" wide track	10	46
BK-5950-144	144" Aluminum fascia with 1-9/16" wide track	10	54



## Part Bags

SKU	Door Panels	Pack Qty	Pack Qty Weight (Lb)
PB-BYP-60AFW-2	2	10	6
PB-BYP-60AFW-3	3	10	8

Hardware Contents	PB-BYP-60AFW-2	PB-BYP-60AFW-3
Door stop-0880	1	1
Single wheel carrier-0200-B	4	6
Floor guide-0351	1	2
Pull-0868-US3	2	3
Screws	Yes	Yes

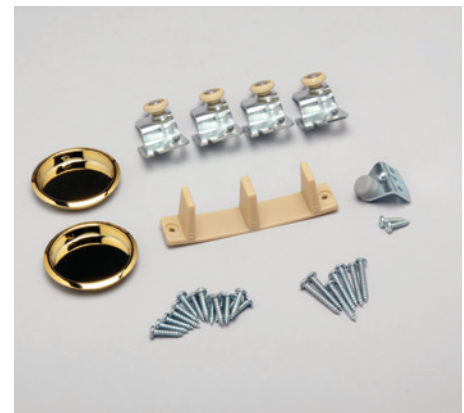

PB-BYP-60AFW-2

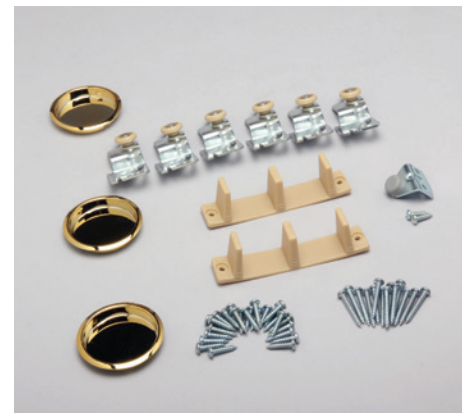

PB-BYP-60AFW-3

# Components

SKU	Description	Pack Qty	Pack Qty Weight (Lb)
BK-0200-A	Single wheel carrier, offset A, 3/4" diameter wheel	100	8
BK-0200-B	Single wheel carrier, offset B, 3/4" diameter wheel	100	8
BK-0351	Non-adjustable door guide	50	3
BK-0351-WT	Non-adjustable door guide (white)	50	3
BK-0354	3/4" riser, fits 0351 and 0353	50	6
BK-0400-A	Single wheel carrier with adjustable dial, offset A, 3/4" diameter	100	13
BK-0400-B	Single wheel carrier with adjustable dial, offset B, 3/4" diameter	100	13
BK-0864-US3	3/4" finger pull (bright brass)	100	1
BK-0865-WT	1-3/4" finger pull (white)	100	2
BN-0353	Adjustable door guide, 3/4" to 1-3/8"	100	4
BN-0868-US10B	2-1/8" finger pull (oil rubbed bronze)	150	5
BN-0868-US15	2-1/8" finger pull (satin nickel)	150	5
BN-0868-US26	2-1/8" finger pull (bright chrome)	150	5
BN-0868-US3	2-1/8" finger pull (bright brass)	150	5
BN-0868-US5	2-1/8" finger pull (antique brass)	150	5
BN-0880	Angle door stop	100	6
PB-0909	Guide for 2 doors up to 1-3/4"	20	4
PB1068-26DA	Sliding door lock, nickel, keyed alike	5	2
PB1068-US26D	Sliding door lock, nickel, keyed different	5	2
PB1068-US3	Sliding door lock, brass, keyed different	5	2
PB1068-US3A	Sliding door lock, brass, keyed alike	5	2



BK-0200-A BK-0200-B BK-0351 BK-0351-WT BK-0354 BK-0400-A BK-0400-B BK-0864-US3 BK-0865-WT BN-0353



BN-0868-US10B BN-0868-US15 BN-0868-US26 BN-0868-US3 BN-0868-US5 BN-0880 PB-0909 PB1068-26DA PB1068-US26D PB1068-US3



PB1068-US3A



# BYP-75AFW Series



## Aluminum wide fascia hardware for 75 lb by-pass doors.

Classic hardware for wide-track mid-weight two and three panel by-pass doors. The BYP-75AFW series features an extra wide track with 1-9/16" smooth fascia and twin wheel carriers for smooth door movement. The wide track and built-in fascia is ideal for thicker 75 lb by-pass doors used in high quality custom closets, pantries, and room dividers.

Door thickness: 1-3/8"

Load rating: Up to 75 lbs per door

Track: Double-J aluminum track with 1-9/16" smooth fascia

Carrier: Twin wheel low friction bearing

Compares to: Hettich/Grant 6065, Johnson 2200F, 118F, Stanley BP75-03

Conforms to: ANSI/BHMA A156.14-2007 Grade 2, D8752

### BYP-75AFW series configuration

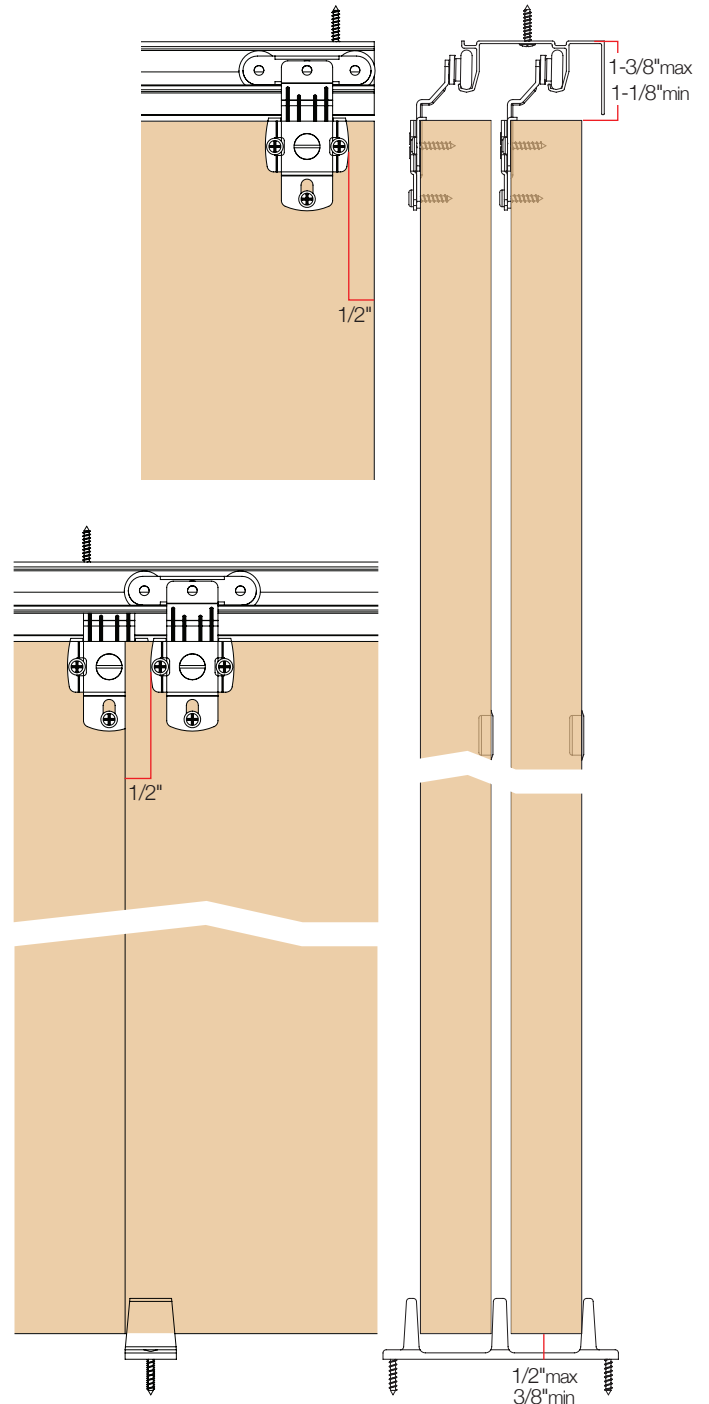
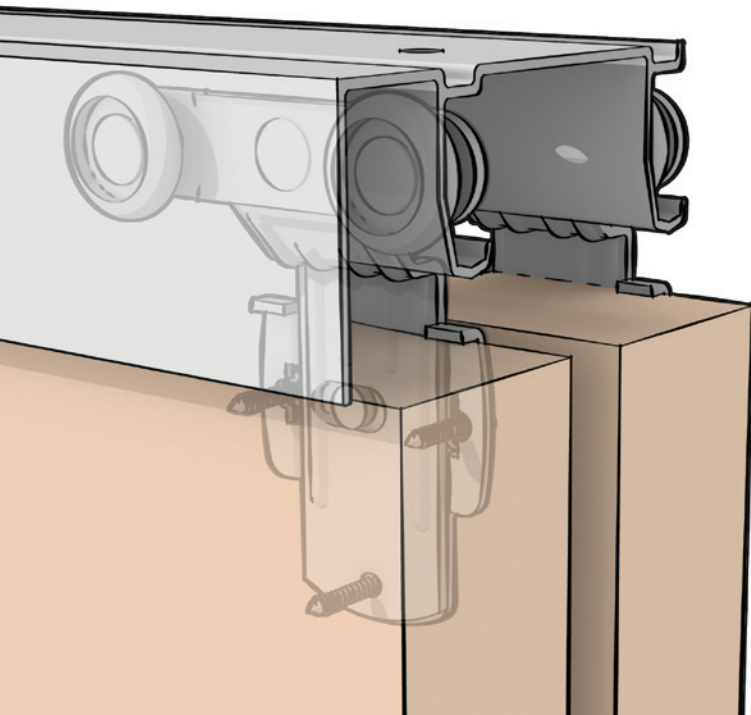

## Packaged Sets

SKU	Door Panel Configuration	Pack Qty	Pack Qty Weight (Lb)
BYP-75AFW-2D-4	2 x 24" doors	5	7
BYP-75AFW-2D-5	2 x 30" doors	5	14
BYP-75AFW-2D-6	2 x 36" doors	5	17
BYP-75AFW-2D-8	2 x 48" doors	5	20
BYP-75AFW-3D-8	3 x 32" doors	5	23

Hardware Contents	BYP-75AFW-2D-4	BYP-75AFW-2D-5	BYP-75AFW-2D-6	BYP-75AFW-2D-8	BYP-75AFW-3D-8
Track	5950-48"	5950-60"	5950-72"	5950-96"	5950-96"
Door stop-0880	1	1	1	1	1
Twin wheel carriers-0400-BTW	4	4	4	4	6
Finger pulls-0868-US3	2	2	2	2	3
Floor guide-0351	1	1	1	1	2
Screws	Yes	Yes	Yes	Yes	Yes



**BYP-75AFW-2D**



**BYP-75AFW-3D**

## Tracks

SKU	Description	Pack Qty	Pack Qty Weight (Lb)
BK-5950-48	48" Aluminum fascia with 1-9/16" wide track	10	18
BK-5950-60	60" Aluminum fascia with 1-9/16" wide track	10	24
BK-5950-72	72" Aluminum fascia with 1-9/16" wide track	10	28
BK-5950-96	96" Aluminum fascia with 1-9/16" wide track	10	36
BK-5950-120	120" Aluminum fascia with 1-9/16" wide track	10	46
BK-5950-144	144" Aluminum fascia with 1-9/16" wide track	10	54



## Part Bags

SKU	Door Panels	Pack Qty	Pack Qty Weight (Lb)
PB-BYP-75AFW-2	2	10	9
PB-BYP-75AFW-3	3	10	14

Hardware Contents	PB-BYP-75AFW-2	PB-BYP-75AFW-3
Door stop-0880	1	1
Twin wheel carrier-0400-BTW	4	6
Floor guide-0351	1	2
Pull-0868-US3	2	3
Screws	Yes	Yes



PB-BYP-75AFW-2

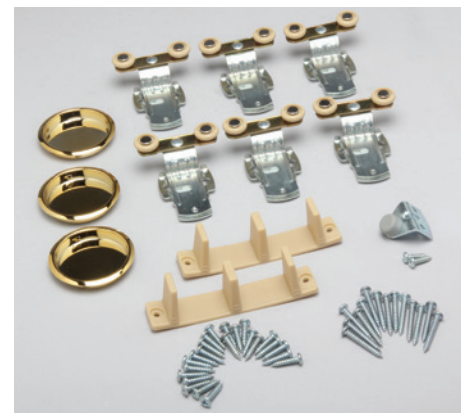

PB-BYP-75AFW-3

# Components

SKU	Description	Pack Qty	Pack Qty Weight (Lb)
BK-0351	Non-adjustable door guide	50	3
BK-0351-WT	Non-adjustable door guide (white)	50	3
BK-0354	3/4" riser, fits 0351 and 0353	50	6
BK-0864-US3	3/4" finger pull (bright brass)	100	1
BK-0865-WT	1-3/4" finger pull (white)	100	2
BN-0353	Adjustable door guide, 3/4" to 1-3/8"	100	4
BN-0868-US10B	2-1/8" finger pull (oil rubbed bronze)	150	5
BN-0868-US15	2-1/8" finger pull (satin nickel)	150	5
BN-0868-US26	2-1/8" finger pull (bright chrome)	150	5
BN-0868-US3	2-1/8" finger pull (bright brass)	150	5
BN-0868-US5	2-1/8" finger pull (antique brass)	150	5
BN-0880	Angle door stop	100	6
PB-0400-ATW	Twin wheel carrier with adjustable dial, offset A, 3/4" diameter	20	4
PB-0400-BTW	Twin wheel carrier with adjustable dial, offset B, 3/4" diameter	20	4
PB-0909	Guide for 2 doors up to 1-3/4"	20	4
PB1068-26DA	Sliding door lock, nickel, keyed alike	5	2
PB1068-US26D	Sliding door lock, nickel, keyed different	5	2
PB1068-US3	Sliding door lock, brass, keyed different	5	2
PB1068-US3A	Sliding door lock, brass, keyed alike	5	2



# BYP-75S | 75A Series

## Steel or aluminum track hardware for 75 lb by-pass doors.

Hardware for mid-weight two panel by-pass doors. The BYP-75S (steel track) and 75A (aluminum track) series features adjustable door guides and 4-wheel carriers for smooth door movement. Ideal for 75 lb by-pass doors used in residential closets, pantries, and room dividers.

- Door thickness: 1-3/8" to 1-3/4"
- Load rating: Up to 75 lbs per door
- Track: 75S - single steel box track  
75A - single aluminum box track
- Carrier: 4-wheel low friction bearing
- Compares to: Hettich/Grant 6064, Stanley BP75-01, BP75-02
- Conforms to: ANSI/BHMA A156.14-2007  
Grade 2, D8742

### BYP-75S/75A series configuration

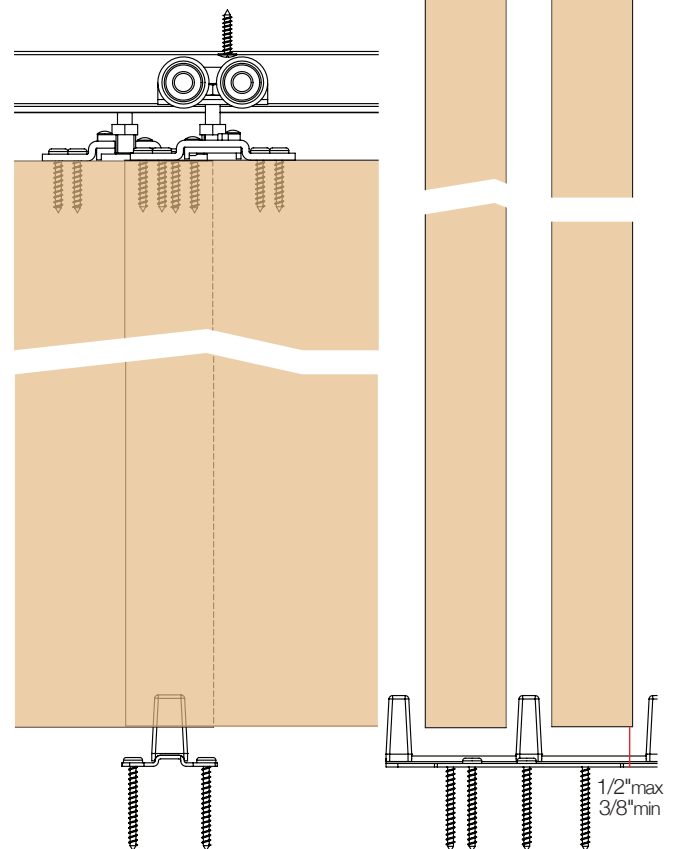
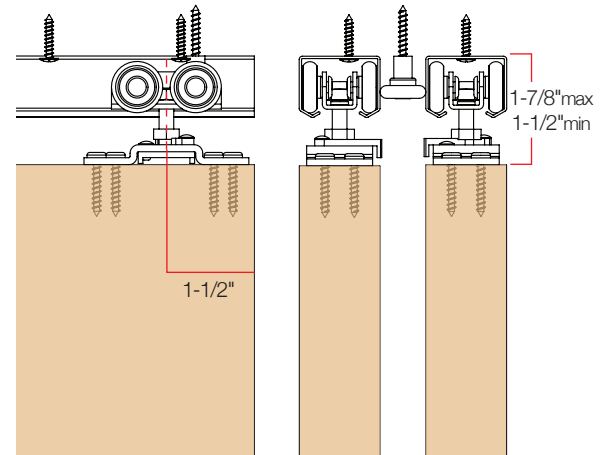
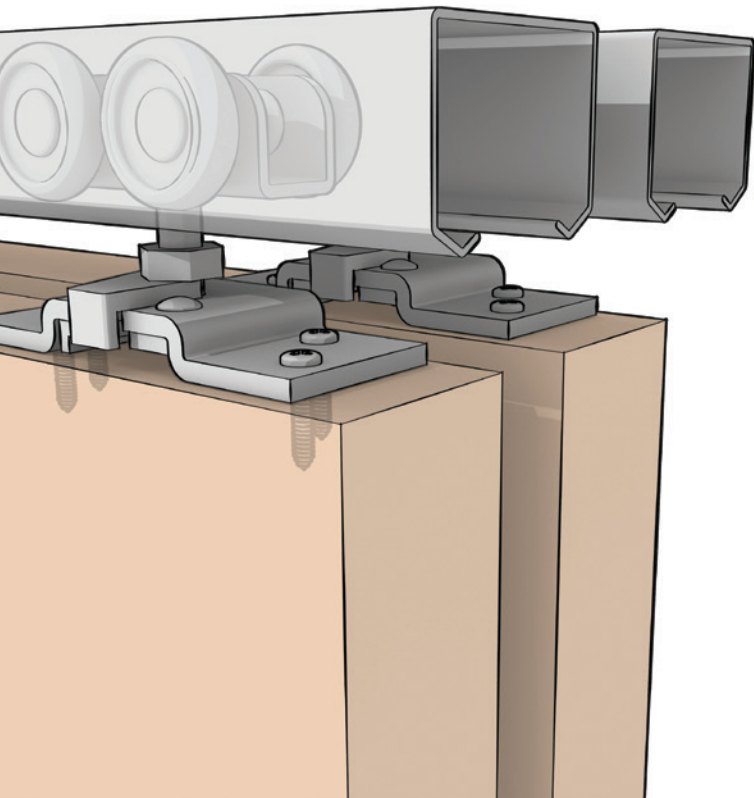

## Packaged Sets

SKU	Door Panel Configuration	Pack Qty	Pack Qty Weight (Lb)
BYP-75S-2D-4	2 x 24" doors	5	23
BYP-75S-2D-5	2 x 30" doors	5	30
BYP-75S-2D-6	2 x 36" doors	5	31
BYP-75S-2D-8	2 x 48" doors	5	41
BYP-75A-2D-4	2 x 24" doors	5	19
BYP-75A-2D-5	2 x 30" doors	5	22
BYP-75A-2D-6	2 x 36" doors	5	24
BYP-75A-2D-8	2 x 48" doors	5	29

Hardware Contents	BYP-75S-2D-4	BYP-75S-2D-5	BYP-75S-2D-6	BYP-75S-2D-8	BYP-75A-2D-4	BYP-75A-2D-5	BYP-75A-2D-6	BYP-75A-2D-8
Track-1599	2 X z47"	2 X z59"	2 X z71"	2 X z95"	-	-	-	-
Track-1602	-	-	-	-	46"	58"	70"	94"
Door stop-0880	1	1	1	1	1	1	1	1
Finger pull-0684-US15P	2	2	2	2	2	2	2	2
Door guide-0909	1	1	1	1	1	1	1	1
Quick release top mount plate-1800-DBA	4	4	4	4	4	4	4	4
Wrench-8665	1	1	1	1	1	1	1	1
4-wheel carriers-1572-QR	4	4	4	4	4	4	4	4
1574-Spacer kit	1	1	1	1	-	-	-	-
Screws	Yes	Yes	Yes	Yes	Yes	Yes	Yes	Yes



BYP-75S-2D

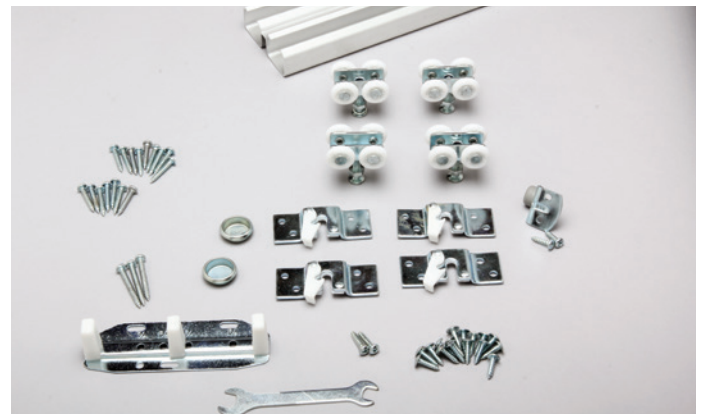

BYP-75A-2D

By-Pass Door Weight (Lb)

BYP-50S | BYP-60S | 60A | 60AFR | 60AFS | 60AFS3 | 60SW | 60AFW | **BYP-75AFW | 75S | 75A**

BYP-100A | BYP-125A | BYP-150A | BYP-250A | BYP-175I | 275I | Components

## Tracks

SKU	Description	Pack Qty	Pack Qty Weight (Lb)
BK-1599-Z47	45" Steel track	20	20
BK-1599-Z55	55" Steel track	20	38
BK-1599-Z59	59" Steel track	20	40
BK-1599-Z63	63" Steel track	20	44
BK-1599-Z71	71" Steel track	20	49
BK-1599-Z95	95" Steel track	10	32
BK-1599-Z119	119" Steel track	10	40
BK-1599-Z143	143" Steel track	10	48



BK-1599 steel tracks



BK-1602 aluminum tracks

Note: For by-pass applications, two box tracks are required.

BK-1602-46	46" Aluminum track	5	10
BK-1602-58	58" Aluminum track	5	12
BK-1602-70	70" Aluminum track	5	15
BK-1602-94	94" Aluminum track	5	20
BK-1602-118	118" Aluminum track	5	23
BK-1602-142	142" Aluminum track	5	30

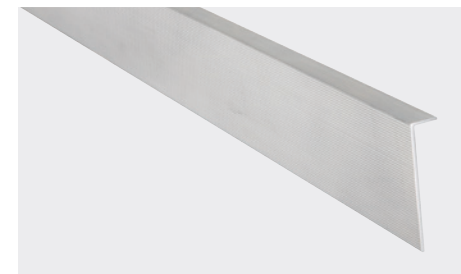

BK-1709 aluminum fascia

### Fascia with Header

BK-1709-72	72" Aluminum fascia	10	17
BK-1709-96	96" Aluminum fascia	10	22

## Part Bags

SKU	Door Panels	Pack Qty	Pack Qty Weight (Lb)
PB-BYP-75-2	2	10	10

Hardware Contents	PB-BYP-75-2
Door stop-0880	1
Finger pull-0864-US15	2
Door guide-0909	1
Quick release top mount plate-1800-DBA	4
Wrench-8665	1
4-wheel carrier-1572-QR	4
Spacer kit-1574	1
Screws	yes



PB-BYP-75-2

# Components

SKU	Description	Pack Qty	Pack Qty Weight (Lb)
BK-0351	Non-adjustable door guide	50	3
BK-0351-WT	Non-adjustable door guide (white)	50	3
BK-0354	3/4" riser, fits 0351 and 0353	50	6
BK-0864-US3	3/4" finger pull (bright brass)	100	1
BK-0865-WT	1-3/4" finger pull (white)	100	2
BK-1572-QR	4-wheel carrier, 7/8" diameter	20	3
BK-1800-DBA	Quick release top mount plate	20	2
BN-0353	Adjustable door guide, 3/4" to 1-3/8"	100	4
BN-0868-US10B	2-1/8" finger pull (oil rubbed bronze)	150	5
BN-0868-US15	2-1/8" finger pull (satin nickel)	150	5
BN-0868-US26	2-1/8" finger pull (bright chrome)	150	5
BN-0868-US3	2-1/8" finger pull (bright brass)	150	5
BN-0868-US5	2-1/8" finger pull (antique brass)	150	5
BN-0880	Angle door stop	100	6
PB-0909	Guide for 2 doors up to 1-3/4"	20	4
PB1068-26DA	Sliding door lock, nickel, keyed alike	5	2
PB1068-US26D	Sliding door lock, nickel, keyed different	5	2
PB1068-US3	Sliding door lock, brass, keyed different	5	2
PB1068-US3A	Sliding door lock, brass, keyed alike	5	2





# BYP-100A Series

## Aluminum track hardware for 100 lb by-pass doors.



Hardware for mid to heavy-weight two panel by-pass doors. The BYP-100A series features adjustable door guides and 4-wheel carriers for smooth door movement. Ideal for 100 lb by-pass doors used in commercial and residential interior closets, pantries, and room dividers.

- Door thickness: 1-3/8" to 1-3/4"
- Load rating: Up to 100 lbs per door
- Track: Double aluminum box track
- Carrier: 4-wheel ball bearing
- Compares to: Hettich/Grant 6064, Stanley BP75-02
- Conforms to: ANSI/BHMA A156.14-2007  
Grade 1, D8741, D8742

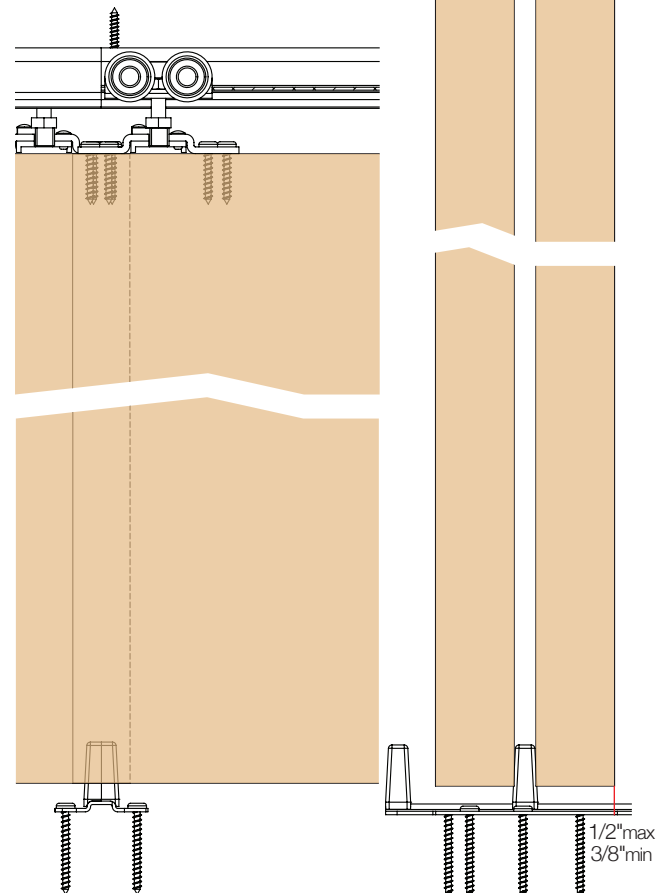
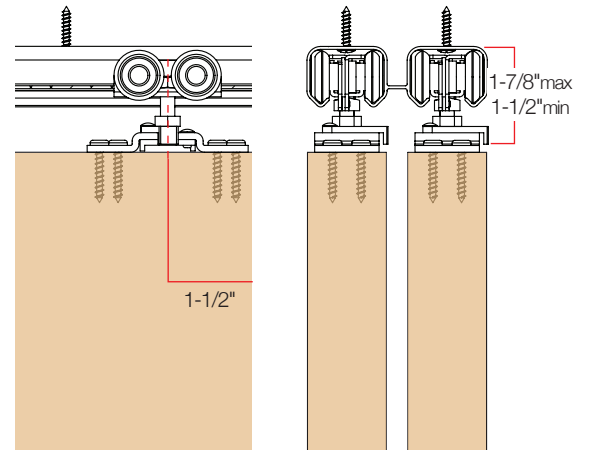

### BYP-100A series configuration

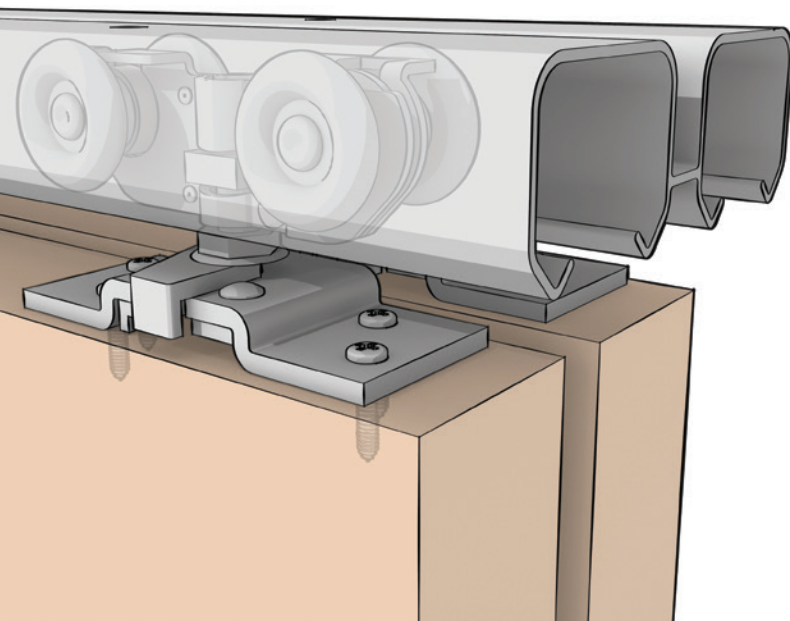

## Packaged Sets

SKU	Door Panel Configuration	Pack Qty	Pack Qty Weight (Lb)
BYP-100A-2D-4	2 x 24" doors	5	18
BYP-100A-2D-5	2 x 30" doors	5	21
BYP-100A-2D-6	2 x 36" doors	5	23
BYP-100A-2D-8	2 x 48" doors	5	28

Hardware Contents	BYP-100A-2D-4	BYP-100A-2D-5	BYP-100A-2D-6	BYP-100A-2D-8
Track	1602-46"	1602-58"	1602-70"	1602-94"
Door stop-0880	1	1	1	1
Finger pull-0684-US15P	2	2	2	2
Door guide-0909	1	1	1	1
Quick release top mount plate-1800-DBA	4	4	4	4
Wrench-8665	1	1	1	1
4-wheel ball bearing carriers-1606-QR	4	4	4	4
Screws	Yes	Yes	Yes	Yes



**BYP-100A-2D**

## Tracks

SKU	Description	Pack Qty	Pack Qty Weight (Lb)
BK-1602-46	46" Aluminum track	5	10
BK-1602-58	58" Aluminum track	5	12
BK-1602-70	70" Aluminum track	5	15
BK-1602-94	94" Aluminum track	5	20
BK-1602-118	118" Aluminum track	5	23
BK-1602-142	142" Aluminum track	5	30
Fascia with Header			
BK-1709-72	72" Aluminum fascia	10	17
BK-1709-96	96" Aluminum fascia	10	22



BK-1602 aluminum tracks



BK-1709 aluminum fascia

## Part Bags

SKU	Door Panels	Pack Qty	Pack Qty Weight (Lb)
PB-BYP-100-2	2	10	10

Hardware Contents	PB-BYP-100-2
Door stop-0880	1
Finger pull-0864-US15	2
Door guide-0909	1
Quick release top mount plate-1800-DBA	4
Wrench-8665	1
4-wheel ball bearing carrier-1606-QR	4
Screws	Yes



PB-BYP-100-2

# Components

SKU	Description	Pack Qty	Pack Qty Weight (Lb)
BK-0351	Non-adjustable door guide	50	3
BK-0351-WT	Non-adjustable door guide (white)	50	3
BK-0354	3/4" riser, fits 0351 and 0353	50	6
BK-0864-US3	3/4" finger pull (bright brass)	100	1
BK-0865-WT	1-3/4" finger pull (white)	100	2
BK-1606-QR	4-wheel ball bearing carrier, 7/8" diameter wheels	20	4
BK-1800-DBA	Quick release top mount plate	20	2
BN-0353	Adjustable door guide, 3/4" to 1-3/8"	100	4
BN-0868-US10B	2-1/8" finger pull (oil rubbed bronze)	150	5
BN-0868-US15	2-1/8" finger pull (satin nickel)	150	5
BN-0868-US26	2-1/8" finger pull (bright chrome)	150	5
BN-0868-US3	2-1/8" finger pull (bright brass)	150	5
BN-0868-US5	2-1/8" finger pull (antique brass)	150	5
BN-0880	Angle door stop	100	6
PB-0909	Guide for 2 doors from 3/4" to 1-3/4"	20	4
PB1068-26DA	Sliding door lock, nickel, keyed alike	5	2
PB1068-US26D	Sliding door lock, nickel, keyed different	5	2
PB1068-US3	Sliding door lock, brass, keyed different	5	2
PB1068-US3A	Sliding door lock, brass, keyed alike	5	2



# BYP-125A Series

## Aluminum track hardware for 125 lb by-pass doors.



Hardware for heavy-weight two panel by-pass doors. The BYP-125A series features adjustable door guides and 4-wheel carriers for smooth door movement. Ideal for 125 lb by-pass doors used in commercial and residential interior closets, pantries, and room dividers.

- Door thickness: 1-3/8" to 1-3/4"
- Load rating: Up to 125 lbs per door
- Track material: Single aluminum box track
- Carrier: 4-wheel low friction bearing
- Compares to: Johnson 134F, 138F
- Conforms to: ANSI/BHMA A156.14-2007 Grade 1, D8731, D8741, D8742

### BYP-125A series configuration

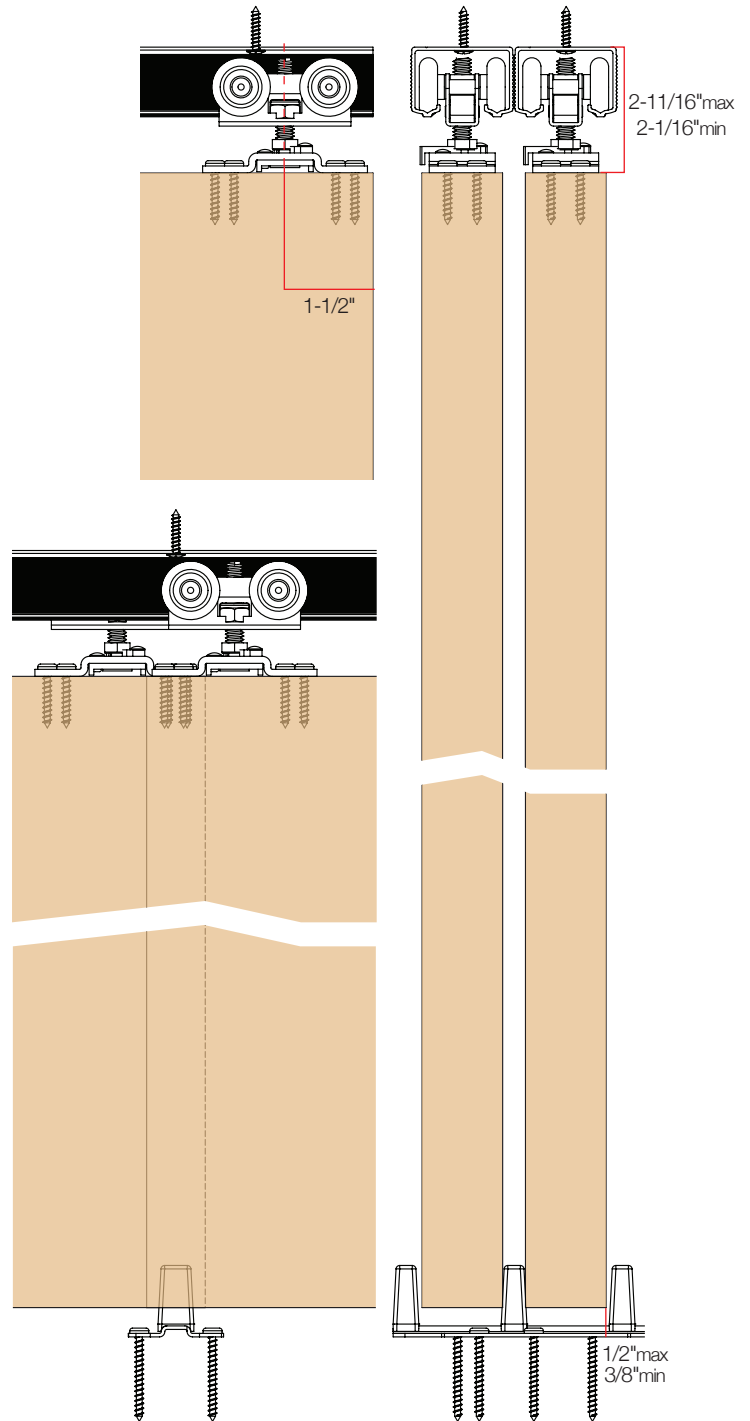
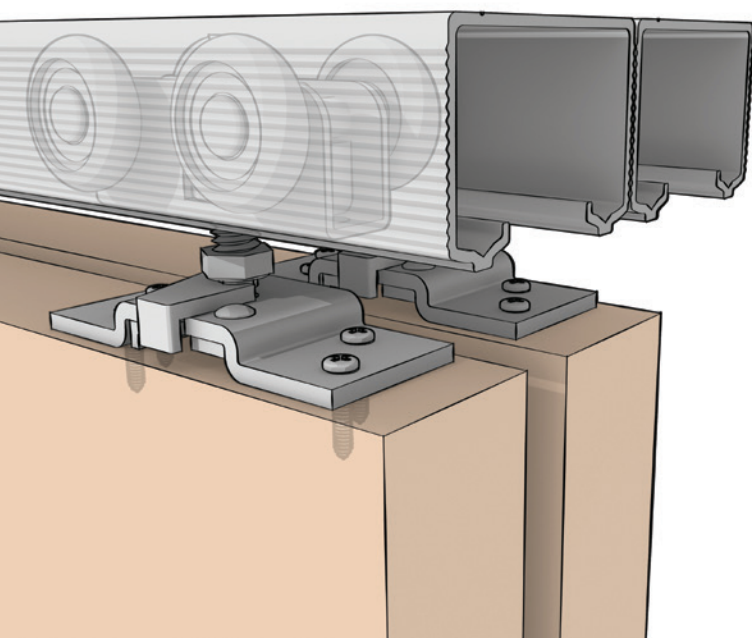

## Packaged Sets

SKU	Door Panel Configurations	Pack Qty	Pack Qty Weight (Lb)
BYP-125A-2D-4	2 x 24" doors	5	28
BYP-125A-2D-5	2 x 30" doors	5	30
BYP-125A-2D-6	2 x 36" doors	5	32
BYP-125A-2D-8	2 x 48" doors	5	35

Hardware Contents	BYP-125A-2D-4	BYP-125A-2D-5	BYP-125A-2D-6	BYP-125A-2D-8
Track-2001	2 x 47"	2 x 59"	2 x 71"	2 x 95"
Door stop-0880	1	1	1	1
Spacer kit-2074 for 1-3/4" doors	1	1	1	1
Door guide-0909	1	1	1	1
Quick release top mount plate-1800-DBA	4	4	4	4
4-wheel carriers-2004	4	4	4	4
Wrench-8710	1	1	1	1
Screws	Yes	Yes	Yes	Yes



**BYP-125A-2D**

## Tracks

SKU	Description	Pack Qty	Pack Qty Weight (Lb)
BK-2001-47	47" Aluminum track	10	14
BK-2001-59	59" Aluminum track	10	17
BK-2001-71	71" Aluminum track	10	20
BK-2001-96	96" Aluminum track	10	28
BK-2001-144	144" Aluminum track	10	42



BK-2001 aluminum tracks

Note: For by-pass applications, two box tracks are required.

Fascia with Header			
SKU	Description	Pack Qty	Pack Qty Weight (Lb)
BK-1709-72	72" Aluminum fascia	10	17
BK-1709-96	96" Aluminum fascia	10	22



BK-1709 aluminum fascia

## Part Bags

SKU	Door Panels	Pack Qty	Pack Qty Weight (Lb)
PB-BYP-125-2	2	10	10

Hardware Contents	PB-BYP-125-2
Spacer kit-2074	1
Door guide-0909	1
Quick release top mount plate-1800-DBA	4
Wrench-8710	1
4-wheel carrier-2004	4
Door stop-0880	1
Screws	yes



PB-BYP-125-2

# Components

SKU	Description	Pack Qty	Pack Qty Weight (Lb)
2074-Spacer	Spacer kit for 1-3/4" doors	20	1
BK-0351	Non-adjustable door guide	50	3
BK-0351-WT	Non-adjustable door guide (white)	50	3
BK-0354	3/4" riser, fits 0351 and 0353	50	6
BK-0864-US3	3/4" finger pull (bright brass)	100	1
BK-0865-WT	1-3/4" finger pull (white)	100	2
BN-0353	Adjustable door guide, 3/4" to 1-3/8"	100	4
BN-0868-US10B	2-1/8" finger pull (oil rubbed bronze)	150	5
BN-0868-US15	2-1/8" finger pull (satin nickel)	150	5
BN-0868-US26	2-1/8" finger pull (bright chrome)	150	5
BN-0868-US3	2-1/8" finger pull (bright brass)	150	5
BN-0868-US5	2-1/8" finger pull (antique brass)	150	5
BN-0880	Angle door stop	100	6
PB-0909	Guide for 2 doors from 3/4" to 1-3/4"	20	4
PB-2004	4-wheel carrier, 1" diameter wheels with quick release top mount plate	20	6
PB1068-26DA	Sliding door lock, nickel, keyed alike	5	2
PB1068-US26D	Sliding door lock, nickel, keyed different	5	2
PB1068-US3	Sliding door lock, brass, keyed different	5	2
PB1068-US3A	Sliding door lock, brass, keyed alike	5	2





# BYP-150A Series

## Aluminum track hardware for 150 lb by-pass doors.



Hardware for heavy-weight two panel by-pass doors. The BYP-150A series features adjustable door guides and 4-wheel ball bearing carriers for smooth and quiet door movement. Ideal for 150 lb by-pass doors used in commercial and residential interior closets, pantries, and room dividers.

Door thickness: 1-3/8" to 1-3/4"

Load rating: Up to 150 lbs per door

Track: Single aluminum box track

Carrier: 4-wheel ball bearing

Compares to: Hettich/Grant 72-034, 72-118, 72-134, 72-138, 72-222, 72-223, 73-034, 73-134, 73-138, Johnson 111SD, Stanley BP150N

Conforms to: ANSI/BHMA A156.14-2007 Grade 1, D8731, D8741, D8742

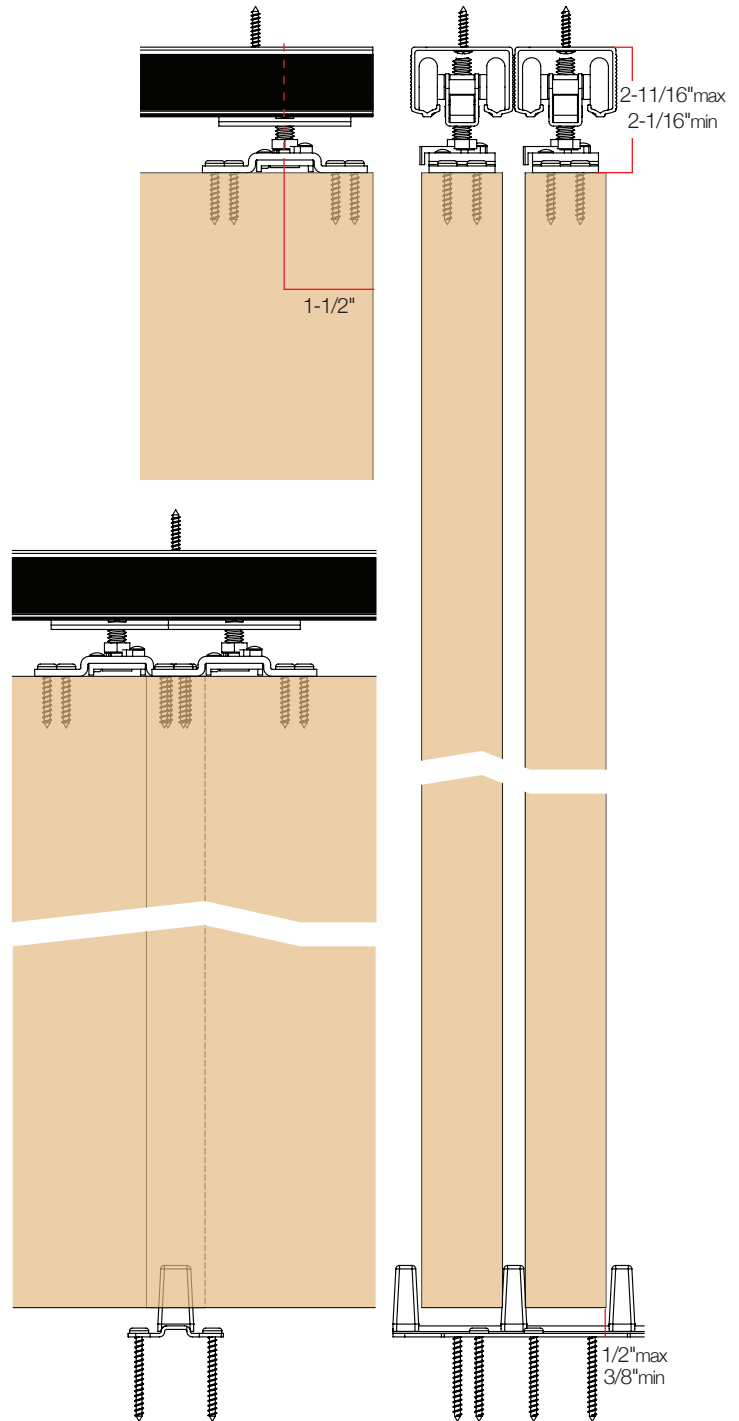

### BYP-150A series configuration

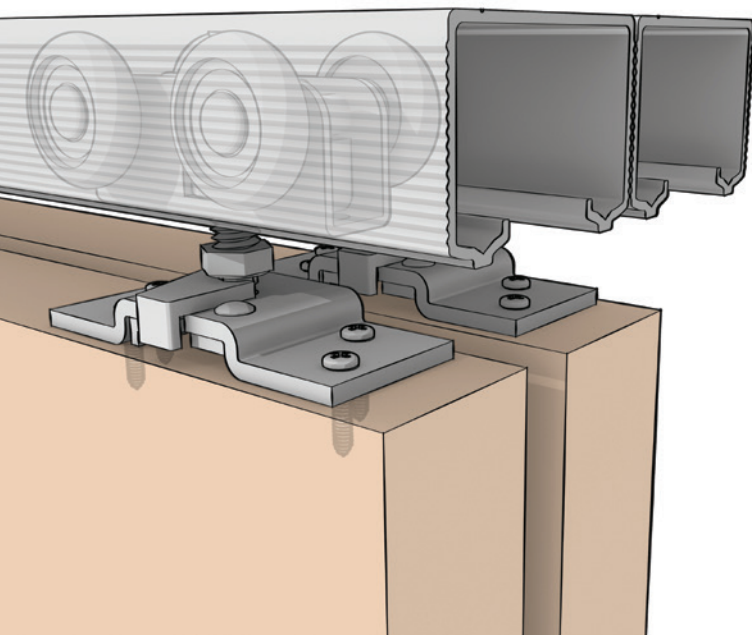

## Packaged Sets

SKU	Door Panel Configuration	Pack Qty	Pack Qty Weight (Lb)
BYP-150A-2D-4	2 x 24" doors	5	29
BYP-150A-2D-5	2 x 30" doors	5	31
BYP-150A-2D-6	2 x 36" doors	5	33
BYP-150A-2D-8	2 x 48" doors	5	36

Hardware Contents	BYP-150A-2D-4	BYP-150A-2D-5	BYP-150A-2D-6	BYP-150A-2D-8
Track-2001	2 x 47"	2 x 59"	2 x 71"	2 x 95"
Door stop-0880	1	1	1	1
Spacer kit-2074 for 1-3/4" doors	1	1	1	1
Door guide-0909	1	1	1	1
Quick release top mount plate-1800-DBA	4	4	4	4
Wrench-8710	1	1	1	1
4-wheel ball bearing carriers-2004-BB	4	4	4	4
Screws	Yes	Yes	Yes	Yes



**BYP-150A-2D**

By-Pass Door Weight (Lb)

BYP-50S | BYP-60S | 60A | 60AFR | 60AFS | 60AFS3 | 60SW | 60AFW | BYP-75AFW | 75S | 75A  
 BYP-100A | BYP-125A | **BYP-150A** | BYP-250A | BYP-175I | 275I | Components

## Tracks

SKU	Description	Pack Qty	Pack Qty Weight (Lb)
BK-2001-47	47" Aluminum track	10	14
BK-2001-59	59" Aluminum track	10	17
BK-2001-71	71" Aluminum track	10	20
BK-2001-96	96" Aluminum track	10	28
BK-2001-144	144" Aluminum track	10	42



BK-2001 aluminum tracks

Note: For by-pass applications, two box tracks are required.

Fascia with Header			
SKU	Description	Pack Qty	Pack Qty Weight (Lb)
BK-1709-72	72" Aluminum fascia	10	17
BK-1709-96	96" Aluminum fascia	10	22



BK-1709 aluminum fascia

## Part Bags

SKU	Door Panels	Pack Qty	Pack Qty Weight (Lb)
PB-BYP-150-2	2	10	10

Hardware Contents	PB-BYP-150-2
Spacer kit-2074	1
Door guide-0909	1
Quick release top mount plate-1800-DBA	4
Wrench-8710	1
4-wheel ball bearing carrier-2004-BB	4
Door stop-0880	1
Screws	Yes

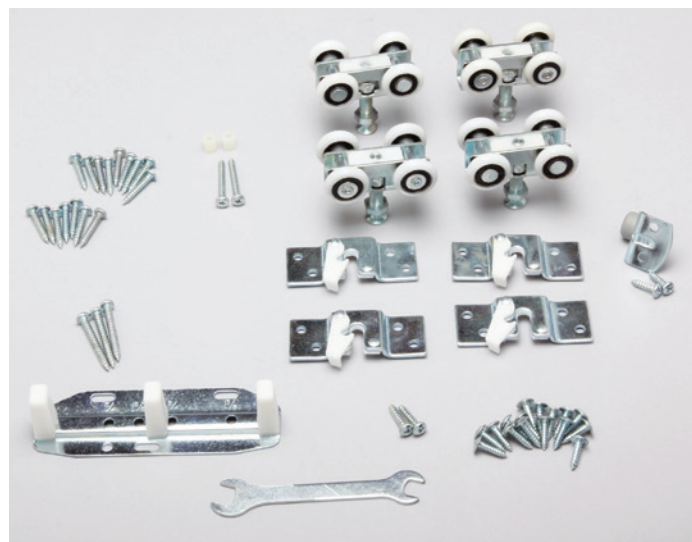

PB-BYP-150-2

# Components

SKU	Description	Pack Qty	Pack Qty Weight (Lb)
2074-Spacer	Spacer kit for 1-3/4" doors	20	1
BK-0351	Non-adjustable door guide	50	3
BK-0351-WT	Non-adjustable door guide (white)	50	3
BK-0354	3/4" riser, fits 0351 and 0353	50	6
BK-0864-US3	3/4" finger pull (bright brass)	100	1
BK-0865-WT	1-3/4" finger pull (white)	100	2
BN-0353	Adjustable door guide, 3/4" to 1-3/8"	100	4
BN-0868-US10B	2-1/8" finger pull (oil rubbed bronze)	150	5
BN-0868-US15	2-1/8" finger pull (satin nickel)	150	5
BN-0868-US26	2-1/8" finger pull (bright chrome)	150	5
BN-0868-US3	2-1/8" finger pull (bright brass)	150	5
BN-0868-US5	2-1/8" finger pull (antique brass)	150	5
BN-0880	Angle door stop	100	6
PB-0909	Guide for 2 doors from 3/4" to 1-3/4"	20	4
PB-2004-BB	4-wheel ball bearing carrier, 1" diameter wheels with quick release top mount plate	10	3
PB1068-26DA	Sliding door lock, nickel, keyed alike	5	2
PB1068-US26D	Sliding door lock, nickel, keyed different	5	2
PB1068-US3	Sliding door lock, brass, keyed different	5	2
PB1068-US3A	Sliding door lock, brass, keyed alike	5	2



# BYP-250A Series

## Aluminum track hardware for 250 lb by-pass doors.



Hardware for super heavy-weight two panel by-pass doors. The BYP-250A series features 4-wheel ball bearing carriers and quick release top mount plate for smooth and quiet door movement. Ideal for 250 lb by-pass doors used in a wide range of commercial and residential interior applications.

- Door thickness: 1-3/8" to 1-3/4"
- Load rating: Up to 250 lbs per door
- Track: Single aluminum box track
- Carrier: 4-wheel ball bearing
- Compares to: Johnson 100SD, Stanley BP250N
- Conforms to: ANSI/BHMA A156.14-2007  
Grade 1, D8731, D8741, D8742, D8011, D8012

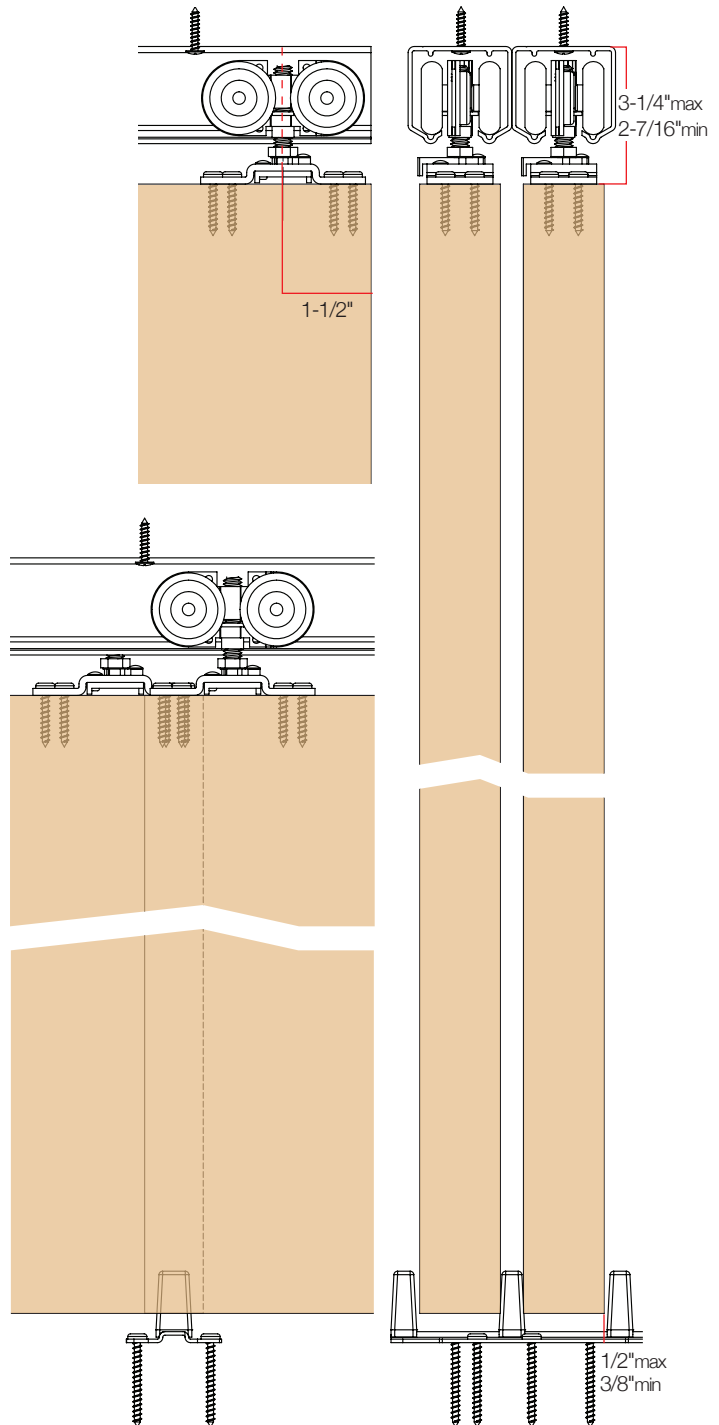

### BYP-250A series configuration

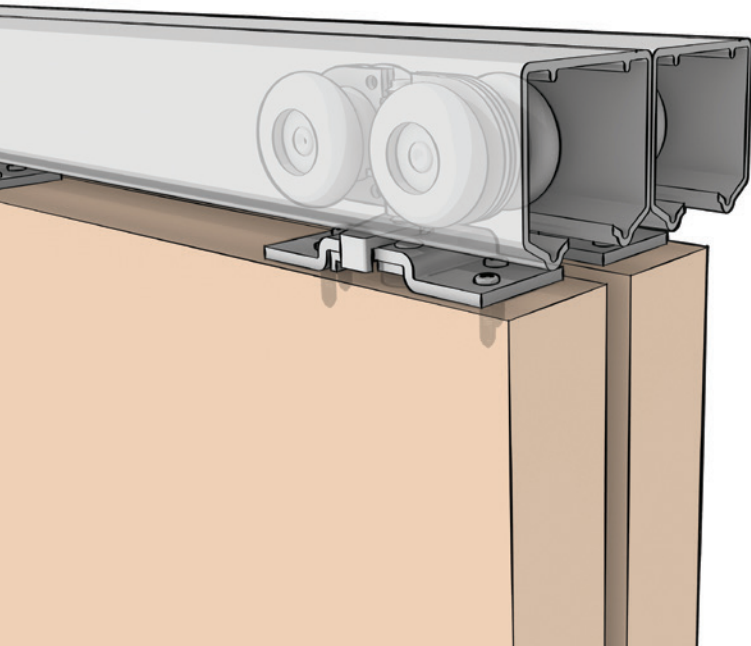

## Packaged Sets

SKU	Door Panel Configuration	Pack Qty	Pack Qty Weight (Lb)
BYP-250A-2D-4	2 x 24" doors	5	35
BYP-250A-2D-5	2 x 30" doors	5	41
BYP-250A-2D-6	2 x 36" doors	5	46
BYP-250A-2D-8	2 x 48" doors	5	58

Hardware Contents	BYP-250A-2D-4	BYP-250A-2D-5	BYP-250A-2D-6	BYP-250A-2D-8
Track-1801	2 x 48"	2 x 60"	2 x 72"	2 x 96"
Spacer kit-2074 for 1-3/4" doors	1	1	1	1
Door guide-0909	1	1	1	1
Quick release top mount plate-1800-DBA	4	4	4	4
Wrench-8710	1	1	1	1
4-wheel ball bearing carriers-1820	4	4	4	4
Screws	Yes	Yes	Yes	Yes



**BYP-250A-2D**

By-Pass Door Weight (Lb)

BYP-50S | BYP-60S | 60A | 60AFR | 60AFS | 60AFS3 | 60SW | 60AFW | BYP-75AFW | 75S | 75A  
 BYP-100A | BYP-125A | BYP-150A | **BYP-250A** | BYP-175I | 275I | Components

## Tracks

SKU	Description	Pack Qty	Pack Qty Weight (Lb)
BK-1801-48	48" Aluminum track	5	9
BK-1801-60	60" Aluminum track	5	12
BK-1801-72	72" Aluminum track	5	14
BK-1801-96	96" Aluminum track	5	19
BK-1801-120	120" Aluminum track	5	23
BK-1801-144	144" Aluminum track	5	28
BK-1801-192	192" Aluminum track	5	37

Note: For by-pass applications, two box tracks are required.

Fascia with Header			
BK-1809-72	72" Aluminum fascia	10	30
BK-1809-96	96" Aluminum fascia	10	41

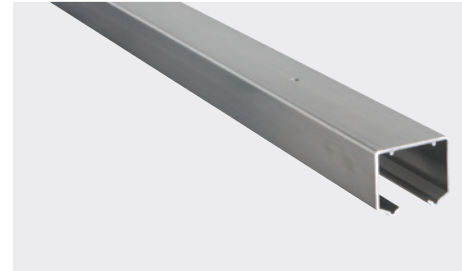

BK-1801 aluminum tracks

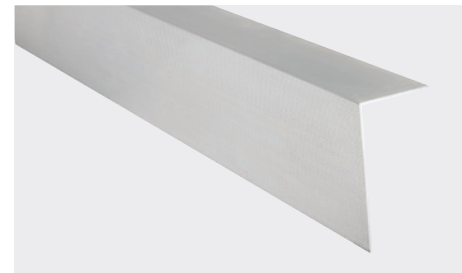

BK-1809 aluminum fascia track

## Part Bags

SKU	Door Panels	Pack Qty	Pack Qty Weight (Lb)
PB-BYP-250-2	2	10	12

Hardware Contents	PB-BYP-250-2
Spacer kit-2074	1
Door guide-0909	1
Quick release top mount plate-1800-DBA	4
Wrench-8710	1
4-wheel ball bearing carrier-1820	4
Screws	Yes



PB-BYP-250-2

# Components

SKU	Description	Pack Qty	Pack Qty Weight (Lb)
2074-Spacer	Spacer kit for 1-3/4" doors	20	1
BK-0351	Non-adjustable door guide	50	3
BK-0351-WT	Non-adjustable door guide (white)	50	3
BK-0354	3/4" riser, fits 0351 and 0353	50	6
BK-0864-US3	3/4" finger pull (bright brass)	100	1
BK-0865-WT	1-3/4" finger pull (white)	100	2
BK-1800-DBA	Quick release top mount plate	20	2
BK-1820	4-wheel ball bearing carrier, 1-1/4" diameter wheels	20	6
BK-1922-144	144" bottom track	5	15
BK-1922-96	96" bottom track	5	10
BN-0353	Adjustable door guide, 3/4" to 1-3/8"	100	4
BN-0868-US10B	2-1/8" finger pull (oil rubbed bronze)	150	5
BN-0868-US15	2-1/8" finger pull (satin nickel)	150	5
BN-0868-US26	2-1/8" finger pull (bright chrome)	150	5
BN-0868-US3	2-1/8" finger pull (bright brass)	150	5
BN-0868-US5	2-1/8" finger pull (antique brass)	150	5
BN-0880	Angle door stop	100	6
PB-0909	Guide for 2 doors from 3/4" to 1-3/4"	20	4
PB-1921	Roller guide	20	
PB1068-26DA	Sliding door lock, nickel, keyed alike	5	2
PB1068-US26D	Sliding door lock, nickel, keyed different	5	2
PB1068-US3	Sliding door lock, brass, keyed different	5	2
PB1068-US3A	Sliding door lock, brass, keyed alike	5	2





# BYP-175I and 275I Series



## Aluminum I-beam hardware for 175 lb and 275 lb by-pass doors.

Hardware for ultra heavy-weight two panel by-pass doors. The BYP-175I and 275I series features a heavy-duty I-beam track for smooth and sturdy door movement. Ideal for 175-275 lb by-pass doors used in a wide range of commercial and residential interior applications.

Door thickness: 1" to 1-3/4"

Load rating: BYP-175I - 175 lbs  
BYP-275I - 275 lbs

Track: Aluminum I-beam track

Carrier: 2 or 4-wheel ball bearing

Compares to: Hettich/Grant 72-034, 72-118, 72-134, 72-138, 72-222, 72-223, Johnson 200SD

Conforms to: 175I - ANSI/BHMA A156.14-2007 Grade 1, D8731, D8741, D8742,  
275I - ANSI/BHMA A156.14-2007 Grade 1, D8731, D8741, D8742, D8011, D8012

### BYP-275I series configuration

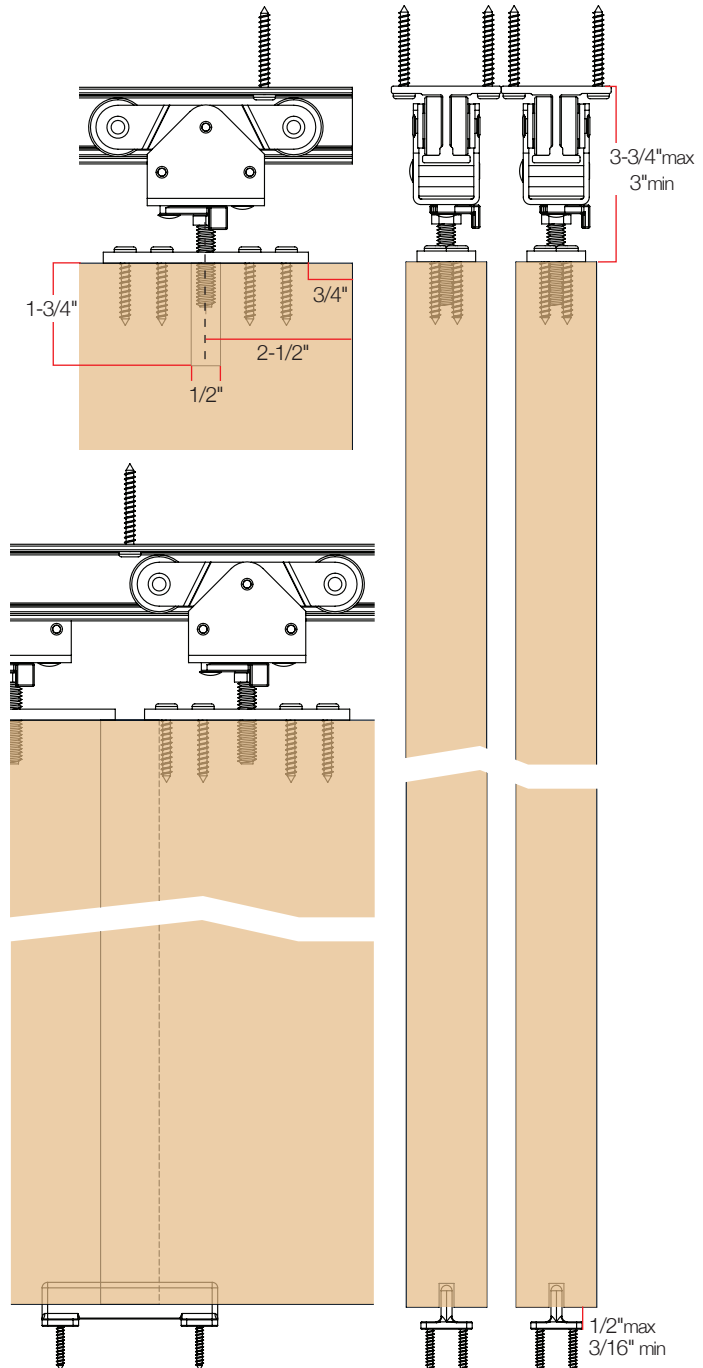
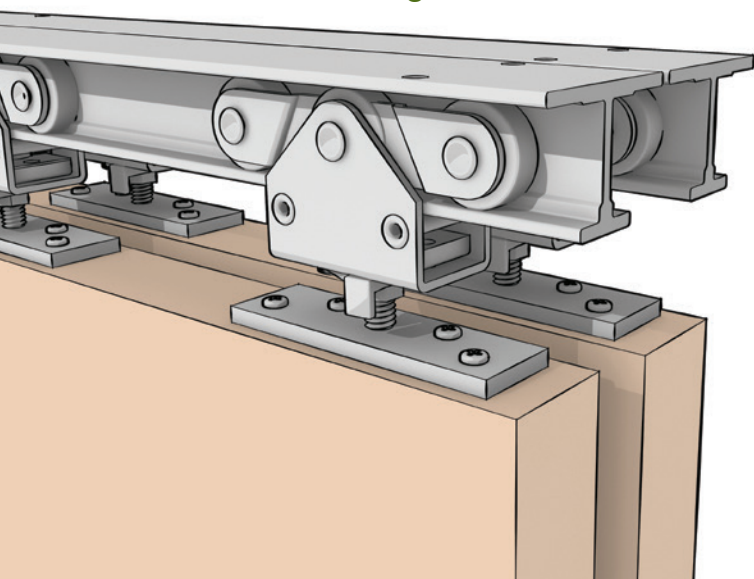

## Packaged Sets

SKU	Door Panel Configuration	Pack Qty	Pack Qty Weight (Lb)
BYP-175I-2D-5	2 x 30" doors	5	49
BYP-175I-2D-6	2 x 36" doors	5	55
BYP-175I-2D-8	2 x 48" doors	5	68
BYP-175I-2D-12	2 x 72" doors	5	95
BYP-275I-2D-5	2 x 30" doors	5	53
BYP-275I-2D-6	2 x 36" doors	5	59
BYP-275I-2D-8	2 x 48" doors	5	72
BYP-275I-2D-12	2 x 72" doors	5	99

Hardware Contents	BYP-175I-2D-5	BYP-175I-2D-6	BYP-175I-2D-8	BYP-175I-2D-12	BYP-275I-2D-5	BYP-275I-2D-6	BYP-275I-2D-8	BYP-275I-2D-12
Track-1901	2 x 60"	2 x 72"	2 x 96"	2 x 144"	2 x 60"	2 x 72"	2 x 96"	2 x 144"
2-wheel ball bearing carrier-8542-QR (175I Series)	4	4	4	4	-	-	-	-
4-wheel ball bearing carrier-8544-QR (275I Series)	-	-	-	-	4	4	4	4
Floor guide-1915	2	2	2	2	2	2	2	2
Door mounting plate assembly-8632	2	2	2	2	2	2	2	2
Screws	Yes	Yes	Yes	Yes	Yes	Yes	Yes	Yes



**BYP-175I-2D**



**BYP-275I-2D**

## Tracks

SKU	Description	Pack Qty	Pack Qty Weight (Lb)
BK-1901-60	60" Aluminum I-beam track	5	16
BK-1901-72	72" Aluminum I-beam track	5	19
BK-1901-96	96" Aluminum I-beam track	5	25
BK-1901-120	120" Aluminum I-beam track	5	31
BK-1901-144	144" Aluminum I-beam track	5	38



Note: For by-pass applications, two I-Beam tracks are required.

## Part Bags

SKU	Door Panels	Pack Qty	Pack Qty Weight (Lb)
PB-BYP-175I-2	2	10	17
PB-BYP-275I-2	2	10	33

Hardware Contents	PB-BYP-175I-2	PB-BYP-275I-2
2-wheel ball bearing carrier-8542-QR	4	-
4-wheel ball bearing carrier-8544-QR	-	4
Floor guide-1915	2	2
Door mounting plate assembly-8632	2 pair	2 pair
Screws	Yes	Yes



**PB-BYP-175I-2**



**PB-BYP-275I-2**

# Components

SKU	Description	Pack Qty	Pack Qty Weight (Lb)
BK-1900	Door stop	20	10
BK-1911	Fixed bottom door guide	20	8
BK-1914-72	Guide rail	20	12
BK-1914-96	Guide rail	20	13
BK-1914-120	Guide rail	20	15
BK-1914-144	Guide rail	20	18
BK-1915	Bottom door guide	20	3
PB1068-26DA	Sliding door lock, nickel, keyed alike	5	2
PB1068-US26D	Sliding door lock, nickel, keyed different	5	2
PB1068-US3	Sliding door lock, brass, keyed different	5	2
PB1068-US3A	Sliding door lock, brass, keyed alike	5	2



BK-1900



BK-1911

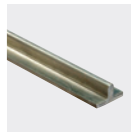

BK-1914-72

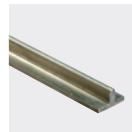

BK-1914-96

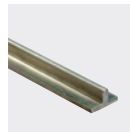

BK-1914-120

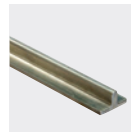

BK-1914-144



BK-1915



PB1068-26DA



PB1068-US26D



PB1068-US3



PB1068-US3A

# BY-PASS COMPONENTS

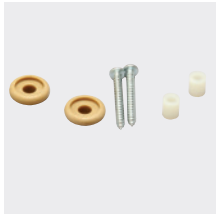

## 1574 Spacer Spacer kit

- **Materials:** Plastic
- **Notes:** Includes screws. Used in the 75S series.



## BK-0354 Carpet riser

- **Materials:** Steel with bright zinc finish
- **Rise:** 3/4" (19mm)
- **Notes:** For mounting 0351 and 0353 floor guides over carpeting.

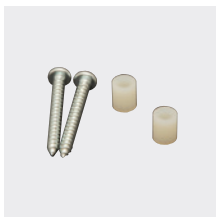

## 2074 Spacer Spacer kit

- **Materials:** Plastic
- **Notes:** Includes screws. Used in the 75S, 125A, 150A and 250A series.



## BK-0400-A Single wheel carrier

- **Materials:** Zinc plated with molded plastic wheels
- **Wheel:** 3/4" diameter
- **Notes:** Side mounted with precise cam adjustment. "A" offset is 3/8".



## BK-0200-A Single wheel carrier

- **Materials:** Zinc plated steel with molded plastic wheels
- **Wheel:** 3/4" diameter
- **Notes:** Side mounted with slot adjust offset. "A" is offset of 3/8".



## BK-0400-B Single wheel carrier

- **Materials:** Zinc plated with molded plastic wheels
- **Wheel:** 3/4" diameter
- **Notes:** Side mounted with precise cam adjustment. "B" offset is 11/16".



## BK-0200-B Single wheel carrier

- **Materials:** Zinc plated steel with molded plastic wheels
- **Wheel:** 3/4" diameter
- **Notes:** Side mounted with slot adjust offset. "B" is offset of 11/16".



## BK-0815 Snugger

- **Materials:** Zinc plated steel and rubber
- **Notes:** Screws onto track.



## BK-0351 Non-adjustable door guide

- **Materials:** High density polyethylene
- **Dimensions:** 4-9/15" x 1" x 11-3/16" (116mm x 25mm x 46mm)
- **Notes:** For door thickness up to 1-3/4".

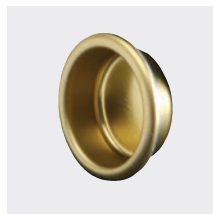

## BK-0864-US3 Pull

- **Finish:** Brass
- **Diameter:** 3/4"



## BK-0351-WT Non-adjustable door guide

- **Materials:** High density polyethylene, white
- **Dimensions:** 4-9/15" x 1" x 11-3/16" (116mm x 25mm x 46mm)
- **Notes:** For door thickness up to 1-3/4".

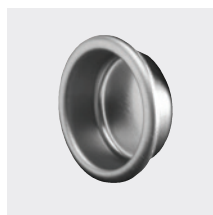

## BK-0864-US15 Pull

- **Finish:** Satin Nickel
- **Diameter:** 3/4"



**BK-0865-WT Pull**

- **Finish:** White
- **Diameter:** 1-3/4"

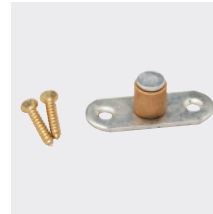

**BK-1911 Fixed bottom door guide**

- **Notes:** Fixed bottom door guide for I-beam applications.



**BK-1572-QR 4-wheel carrier**

- **Materials:** Steel with zinc finish
- **Wheel:** 7/8" (22mm) diameter
- **Notes:** Wheel self-align for consistent contact with track. Lubricated plastic wheels.

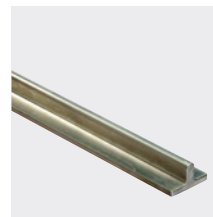

**BK-1914-72 Bottom guard rail**

- **Materials:** Aluminum
- **Guide:** 7/8" x 1/2" (22mm x 13mm)
- **Notes:** Door bottom prep requires 1/4" (6mm) kerf and 9/16" (14mm) depth. Pre-punched for use with flat head screws.



**BK-1606-QR 4-wheel ball bearing carrier**

- **Materials:** Steel with brass dichromate finish
- **Wheel:** 7/8" (22mm) diameter
- **Notes:** Wheels self-align for consistent contact with track. Lubricated plastic wheels on steel ball bearing shafts.



**BK-1914-96 Bottom guard rail**

- **Materials:** Aluminum
- **Guide:** 7/8" x 1/2" (22mm x 13mm)
- **Notes:** Door bottom prep requires 1/4" (6mm) kerf and 9/16" (14mm) depth. Pre-punched for use with flat head screws.



**BK-1800-DBA Quick release top mount**

- **Materials:** Zinc plated steel with plastic lever
- **Notes:** Attaches to door. Carrier attaches to plate. Quick release feature.



**BK-1914-120 Bottom guard rail**

- **Materials:** Aluminum
- **Guide:** 7/8" x 1/2" (22mm x 13mm)
- **Notes:** Door bottom prep requires 1/4" (6mm) kerf and 9/16" (14mm) depth. Pre-punched for use with flat head screws.



**BK-1820 4-wheel ball bearing carrier**

- **Materials:** Zinc plated steel
- **Wheel:** 1-1/4" (32mm) diameter
- **Notes:** Wheels self-align for consistent contact with track. Lubricated plastic wheels on steel shafts with steel ball bearings.



**BK-1914-144 Bottom guard rail**

- **Materials:** Aluminum
- **Guide:** 7/8" x 1/2" (22mm x 13mm)
- **Notes:** Door bottom prep requires 1/4" (6mm) kerf and 9/16" (14mm) depth. Pre-punched for use with flat head screws.



**BK-1900 Door stop**

- **Notes:** Heavy-duty I-Beam door stop.



**BK-1915 Bottom door guide**

- **Materials:** Aluminum
- **Guide:** 7/8" x 3/4" x 3" (22mm x 19mm x 76mm)
- **Notes:** Door bottom prep requires 1/4" (6mm) kerf and 9/16" (14mm) depth.



- BK-1922-144** Bottom track
- **Materials:** Extruded aluminum
  - **Channel:** 5/8" x 3/4" (16mm x 19mm)
  - **Notes:** Screws not provided. Mortised into floor or surface mounted.



- BK-7400-A** Single wheel carrier
- **Materials:** Zinc plated steel with molded plastic wheels
  - **Wheel:** 7/8" diameter
  - **Notes:** Side mounted with precise cam adjustment. "A" offset is 3/8".

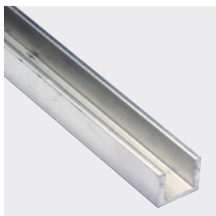

- BK-1922-96** Bottom track
- **Materials:** Extruded aluminum
  - **Channel:** 5/8" x 3/4" (16mm x 19mm)
  - **Notes:** Screws not provided. Mortised into floor or surface mounted.



- BK-7400-B** Single wheel carrier
- **Materials:** Zinc plated steel with molded plastic wheels
  - **Wheel:** 7/8" diameter
  - **Notes:** Side mounted with precise cam adjustment. "B" offset is 11/16".



- BK-7200-A** Single wheel carrier
- **Materials:** Zinc plated steel with molded plastic wheels
  - **Wheel:** 7/8" diameter
  - **Notes:** Side mounted with slot adjust offset. "A" offset is 3/8".



- BN-0353** Adjustable door guide
- **Materials:** High density polyethylene
  - **Notes:** Adjustable guide from 3/4" (19mm) to 1-3/8" (35mm).



- BK-7200-ATW** Twin wheel carrier
- **Materials:** Zinc plated steel with molded plastic wheels
  - **Wheel:** 7/8" diameter
  - **Notes:** Side mounted with slot adjust offset. "A" offset is 3/8".



- BN-0868-US10B** Pull
- **Finish:** Oil rubbed bronze
  - **Diameter:** 2-1/8"



- BK-7200-B** Single wheel carrier
- **Materials:** Zinc plated steel with molded plastic wheels
  - **Wheel:** 7/8" diameter
  - **Notes:** Side mounted with slot adjust offset. "B" offset is 11/16".



- BN-0868-US15** Pull
- **Finish:** Satin nickel
  - **Diameter:** 2-1/8"



- BK-7200-BTW** Twin wheel carrier
- **Materials:** Zinc plated steel with molded plastic wheels
  - **Wheel:** 7/8" diameter
  - **Notes:** Side mounted with slot adjust offset. "B" offset is 11/16".



- BN-0868-US26** Pull
- **Finish:** Bright chrome
  - **Diameter:** 2-1/8"



**BN-0868-US3 Pull**

- **Finish:** Bright brass
- **Diameter:** 2-1/8"



**BN-0868-US5 Pull**

- **Finish:** Antique brass
- **Diameter:** 2-1/8"



**BN-0880 Angle door stop**

- **Materials:** Zinc plated steel and rubber
- **Dimensions:** 1-1/4" x 1-1/4" x 7/8" (32mm x 32mm x 22mm)
- **Notes:** Keeps rear door pull exposed. Mounts on door.



**PB-0340 Jump-proof guard**

- **Materials:** Steel with brass finish
- **Notes:** Includes four guards with screws.



**PB-0352 Adjustable door guide**

- **Materials:** Steel and plastic
- **Notes:** Adjustable guide from 3/4" (19mm) to 1-3/8" (35mm).



**PB-0400-ATW Twin wheel carrier**

- **Materials:** Zinc plated steel with molded plastic wheels
- **Wheel:** 3/4" diameter
- **Notes:** Side mounted with precise cam adjustment. "A" is offset 3/8".



**PB-0400-BTW Twin wheel carrier**

- **Materials:** Zinc plated steel with molded plastic wheels
- **Wheel:** 3/4" diameter
- **Notes:** Side mounted with precise cam adjustment. "B" is offset 11/16".



**PB-0909 Adjustable door guide**

- **Materials:** Steel with bright zinc and molded plastic
- **Guide:** 4-7/8" x 1-5/8" x 1-3/16" (124mm x 41mm x 30mm)
- **Notes:** Adjustable guide from 3/4" (19mm) to 1-3/4" (44mm).



**PB-1921 Bottom roller guide**

- **Materials:** Zinc plated steel, bronze roller
- **Guide:** 1" x 3-1/2" x 3/16" (25mm x 89mm x 5mm)
- **Post:** 2-1/2" x 5/16" (64mm x 8mm)



**PB-2004 4-wheel carrier**

- **Materials:** Zinc plated steel
- **Wheel:** 1" (25mm) diameter
- **Notes:** Wheels self-align for consistent contact with track. Lubricated plastic wheels.



**PB-2004-BB 4-wheel ball bearing carrier**

- **Materials:** Zinc plated steel
- **Wheel:** 1" (25mm) diameter
- **Notes:** Wheels self-align for consistent contact with track. Lubricated plastic wheels.



**PB-3126 Side wall bracket**

- **Materials:** Steel with bright zinc
- **Notes:** Mounts along track every foot.





**PB1068-26DA** Lock

- **Materials:** Steel
- **Notes:** Nickel, keyed alike



**PB1068-US26D** Lock

- **Materials:** Steel
- **Notes:** Nickel, keyed different (5 key random).



**PB1068-US3** Lock

- **Materials:** Steel
- **Notes:** Brass, keyed different (5 key random).



**PB1068-US3A** Lock

- **Materials:** Steel
- **Notes:** Brass, keyed alike.

# BY-PASS CROSS-REFERENCE

KV Series	Hettich/Grant	Johnson	Stanley
BYP-50S	6034	1166, 1138, 113F	–
BYP-60S	6065	1166, 1138, 113F	BP60, BPD60
BYP-60A	6065	2222	BP60, BPD60, BP75-03
BYP-60AFR	6065	2204F, 2200F	BP75-06
BYP-60AFS	6065	2200F	BP75-06
BYP-60AFS3	6065	2200F	BP75-05
BYP-60SW	6065	–	BP75-01
BYP-60AFW	6065	2200F	BP75-03
BYP-75AFW	6065	2200F, 118F	BP75-03
BYP-75S   75A	6064	–	BP75-01, BP75-02
BYP-100A	6064	–	BP75-02
BYP-125A	–	134F, 138F	–
BYP-150A	72-034, 72-118, 72-134, 72-138, 72-222, 72-223, 73-034, 73-134, 73-138	111SD	BP150N
BYP-250A	–	100SD	BP250N
BYP-175I   275I	72-034, 72-118, 72-134, 72-138, 72-222, 72-223	200SD	–





# POCKET DOORS



**Classic door hardware for pocket doors.  
Simple to install. Built to last.**

Pocket door hardware sets for simple installations of custom closet doors and room dividers.

- Pocket Series Overview . . . . . 108
- PKT-75S | 75A . . . . . 110
- PKT-100A . . . . . 114
- PKT-125A . . . . . 118
- PKT-150A . . . . . 122
- PKT-250A . . . . . 126
- Components . . . . . 130
- Competitor Cross-Reference . . . . 133

# POCKET SERIES OVERVIEW

## PKT POCKET



### Naming Structure

PKT-75S-4

1 2 3 4

1 POCKET	2 Door Weight	3 Track Type	4 Track Length
PKT	75	S (Steel)	4'
	100	A (Aluminum)	5'
	125		6'
	150		8'
	250		

PB-PKT-75

1 2 3

1 Part Bag	2 POCKET	3 Door Weight
PB	PKT	75
		100
		125
		150
		250

BK = Bulk  
PB = Part Bag

### Ordering Instructions

Once the series of sliding door hardware has been identified by confirming your project's door weight and the door thickness, the next step is to go to the series page.

#### Option 1: Complete Package Sets

Order a package set that has your required door opening length. The package set includes the noted track length and hardware for installation, along with installation instructions.

#### Option 2: Tracks and Parts Bags

Order from the Tracks and Part Bags section. Choose the correct track length. Most tracks may be cut-to-size

in the field. Then choose the correct part bag based on the number of panel doors. Installation instructions are included in each part bag.

#### Individual Components

Bulk components for accessory options or replacement parts are available.

## Series Overview Matrix

		POCKET					
		PKT-75S	PKT-75A	PKT-100A	PKT-125A	PKT-150A	PKT-250A
Light	20 lb						
	30 lb						
	50 lb						
Standard	60 lb						
	75 lb	•	•				
	100 lb			•			
Heavy Duty	125 lb				•		
	150 lb					•	
	175 lb						
	250 lb						•
	275 lb						
Track		1599	1601K	1601K	2001K	2001K	1801K
Steel		•					
Aluminum			•	•	•	•	•
Fascia							
Non-Fascia		•	•	•	•	•	•
Type	Box	•	•	•	•	•	•
	Double J						
	I-Beam						
Min. Door Thickness	3/4"						
	7/8"						
	1"						
	1-1/8"	•	•	•			
	1-3/8"	•	•	•	•	•	•
	1-3/4"	•	•	•	•	•	•
Carrier		1582 4-wheel	1582 4-wheel	1606-QR 4-wheel BB	2004 4-wheel	2004-BB 4-wheel	1820 4-wheel BB

This product overview matrix shows the six hardware series in Knappe and Vogt's pocket door category. Using the matrix, you can compare each series to help you choose the one that will fit best within your project. Go to the series pages for more in-depth information including tracks, parts bags and components.

# PKT-75S and 75A Series



## Steel and aluminum track 75 lb pocket door hardware.

Hardware for medium-weight single pocket doors. The PKT-75S (steel track) and 75A (aluminum track) series features a 4-wheel spring carrier for smooth gliding movement. Ideal for 75 lb pocket doors used in a variety of residential applications. Bi-parting doors are possible with the optional bi-parting door kit.

Door thickness: 1-1/8" to 1-3/4"

Load rating: Up to 75 lbs per door

Track: 75S - Steel box track  
75A - Aluminum box track

Carrier: 4-wheel low friction bearing

Compares to: Hettich/Grant 6023, 6053, Johnson 2800, 2850, 111PD, Stanley PD75

Conforms to: ANSI/BHMA A156.14-2007  
Grade 1, D8691, D8692  
With bi-parting kit - Grade 1, D8721, D8722

### PKT-75S | 75A series configuration

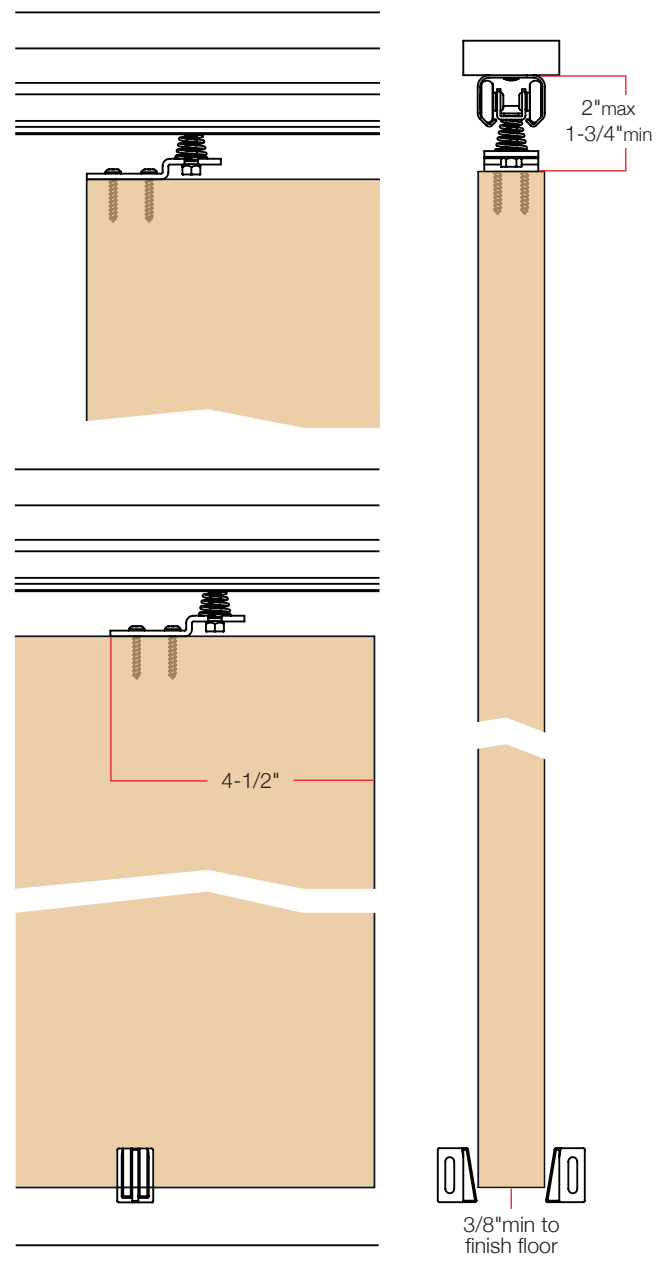
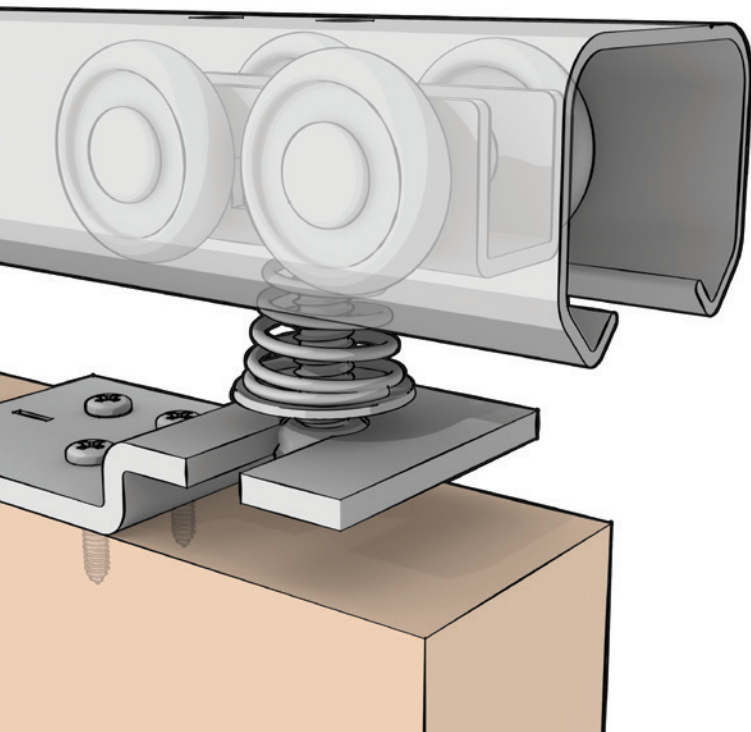

## Packaged Sets

SKU	Door Panel Configuration	Pack Qty	Pack Qty Weight (Lb)
PKT-75S-4	1 x 24" door	5	13
PKT-75S-5	1 x 30" door	5	16
PKT-75S-6	1 x 36" door	5	16
PKT-75S-8	1 x 48" door	5	22
PKT-75A-4	1 x 24" door	5	11
PKT-75A-5	1 x 30" door	5	13
PKT-75A-6	1 x 36" door	5	14
PKT-75A-8	1 x 48" door	5	17

Hardware Contents	PKT-75S-4	PKT-75S-5	PKT-75S-6	PKT-75S-8	PKT-75A-4	PKT-75A-5	PKT-75A-6	PKT-75A-8
Track-1599	47"	59"	71"	95"	-	-	-	-
Track-1601K	-	-	-	-	47"	59"	71"	95"
4-wheel spring carrier-1582	2	2	2	2	2	2	2	2
Top mount plate 1507-TM	2	2	2	2	2	2	2	2
Door guide-0883	2	2	2	2	2	2	2	2
Bumper-0881	1	1	1	1	1	1	1	1
Wrench-8665-B	1	1	1	1	1	1	1	1
Screws	Yes	Yes	Yes	Yes	Yes	Yes	Yes	Yes

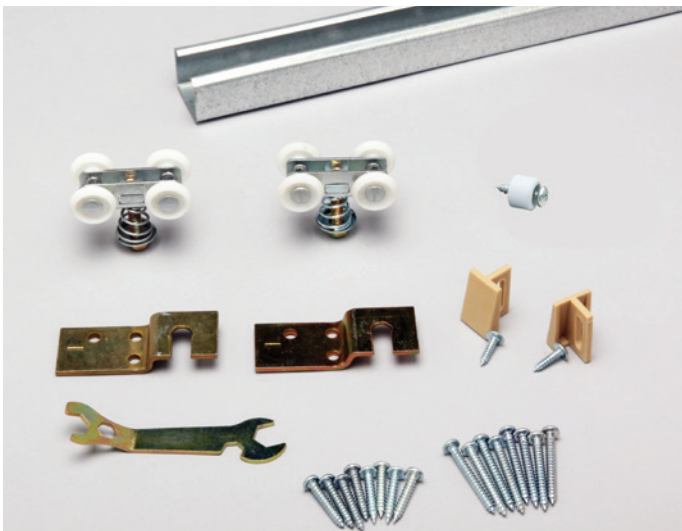

PKT-75S-4



PKT-75A-4



## Tracks

SKU	Description	Pack Qty	Pack Qty Weight (Lb)
BK-1599-Z47	47" Steel box track	20	27
BK-1599-Z55	55" Steel box track	20	38
BK-1599-Z59	59" Steel box track	20	40
BK-1599-Z63	63" Steel box track	20	44
BK-1599-Z71	71" Steel box track	20	49
BK-1599-Z95	95" Steel box track	10	32
BK-1599-Z119	119" Steel box track	10	40
BK-1601-47K	47" Aluminum key-holed box track	10	11
BK-1601-59K	59" Aluminum key-holed box track	10	14
BK-1601-71K	71" Aluminum key-holed box track	10	17
BK-1601-96K	95" Aluminum key-holed box track	10	22



BK-1599 Series



BK-1601K Series

## Part Bags

SKU	Door Panels	Pack Qty	Pack Qty Weight (Lb)
PB-PKT-75	1	40	22

Hardware Contents	PB-PKT-75
4-wheel spring carrier-1582	2
Top mount plate-1507-TM	2
Door guide-0899	1
Door Bumper-0881	1
Wrench-8665-B	1
Screws	Yes

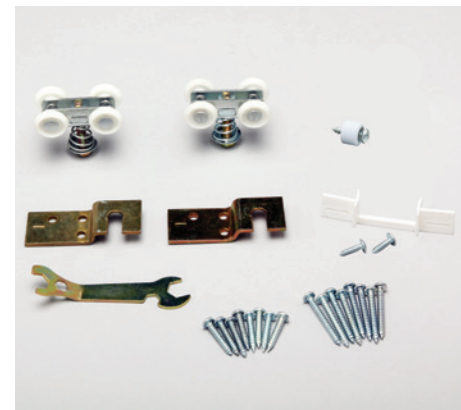

PB-PKT-75

# Components

SKU	Description	Pack Qty	Pack Qty Weight (Lb)
BK-0881	Door Bumper	80	1
BK-0883	Pocket door guides	100	2
BK-0889	Pocket door guide	50	1
BK-1353-3.5	Floor plate, jamb spacer 3-1/2"	300	18
BK-1353-4.5	Floor plate, jamb spacer 4-1/2"	150	11
BK-1355	Jamb stiffener 81-3/4"	30	23
BK-1355-85	Jamb stiffener 85-3/4"	30	26
BK-1355-97	Jamb stiffener 97-3/4"	30	30
BK-1507-TM	Top mount plate	500	55
BK-1582	4-wheel spring carrier, 7/8" diameter wheels	500	55
BN-0868-US10B	2-1/8" finger pull (oil rubbed bronze)	150	5
BN-0868-US15	2-1/8" finger pull (satin nickel)	150	5
BN-0868-US26	2-1/8" finger pull (bright chrome)	150	5
BN-0868-US3	2-1/8" finger pull (bright brass)	150	5
BN-0868-US5	2-1/8" finger pull (antique brass)	150	5
BX1062-26DA	Pocket door lock keyed alike nickel	5	2
BX1062-US26D	Pocket door lock keyed different nickel	5	2
BX1062-US3	Pocket door lock keyed different brass	5	2
BX1062-US3A	Pocket door lock keyed alike brass	5	2
PB-0884-US15	Edge pull (satin nickel)	10	1
PB-0884-US3	Edge pull (bright brass)	10	1
PB-1038-US3	Passage pull (satin nickel)	6	2
PB-1038-US15	Passage pull (bright brass)	6	2
PB-1039-US15	Privacy lock (satin nickel)	6	3
PB-1039-US3	Privacy lock (bright brass)	6	3
PB-1437	Bi-parting door adapter kit	6	4



BK-0881 BK-0883 BK-0889 BK-1353-3.5 BK-1353-4.5 BK-1355 BK-1355-85 BK-1355-97 BK-1507-TM BK-1582



BN-0868-US10B BN-0868-US15 BN-0868-US26 BN-0868-US3 BN-0868-US5 BX1062-26DA BX1062-US26D BX1062-US3 BX1062-US3A PB-0884-US15



PB-0884-US3 PB-1038-US15 PB-1038-US3 PB-1039-US15 PB-1039-US3 PB-1437

# PKT-100A Series



## Aluminum track hardware for 100 lb pocket doors.

Hardware for mid to heavy-weight single pocket doors. The PKT-100A series features a 4-wheel ball bearing carrier for smooth gliding movement with quick release top mount plate. Ideal for 100 lb pocket doors used in a variety of commercial and residential applications. Bi-parting doors are optional with the bi-parting door kit.

- Door thickness: 1-1/8" to 1-3/4"
- Load rating: Up to 100 lbs per door
- Track: Aluminum box track
- Carrier: 4-wheel ball bearing
- Compares to: Johnson IIPD
- Conforms to: ANSI/BHMA A156.14-2007  
 Grade 1, D8691, D8692  
 With bi-parting kit - Grade 1, D8721, D8722

### PKT-100A series configuration

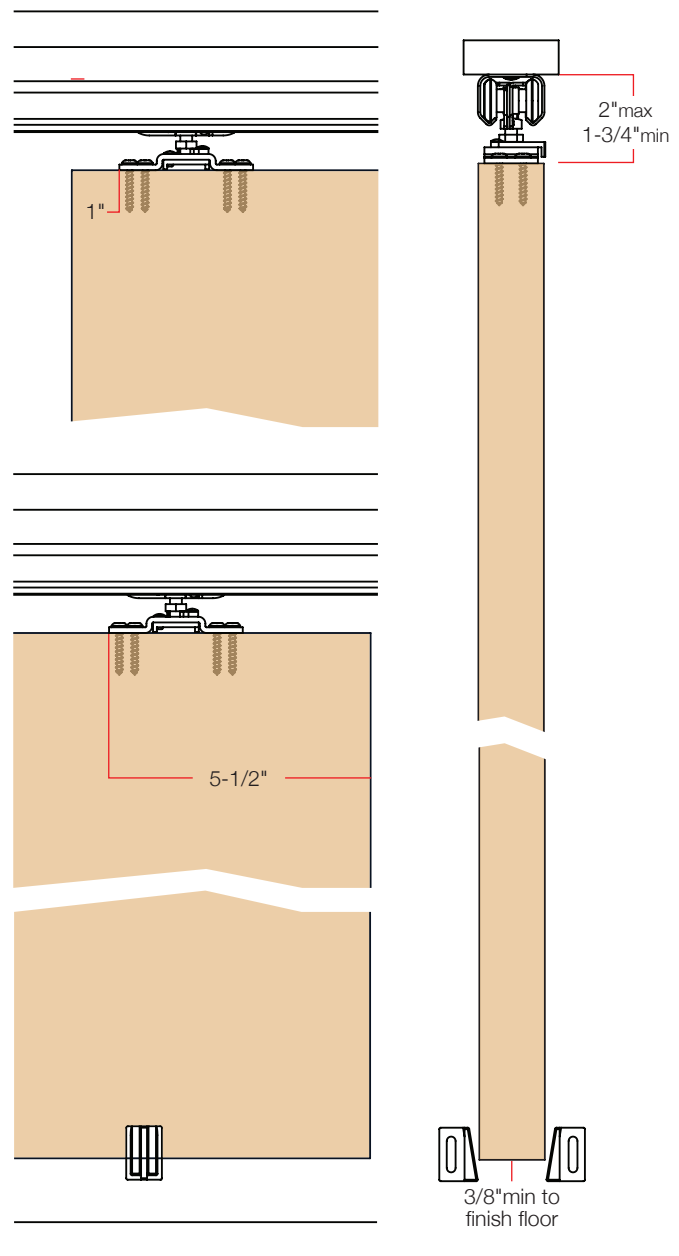
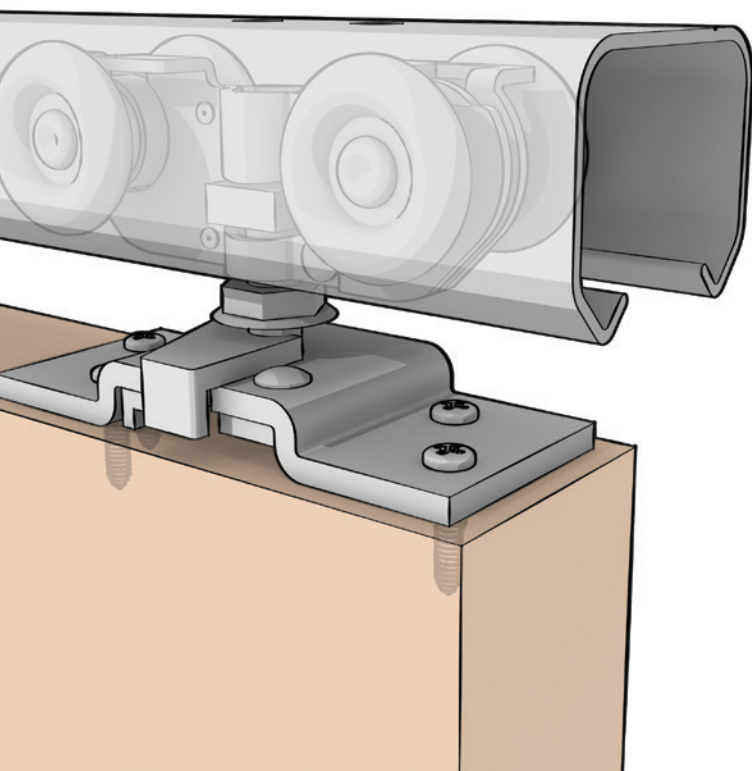

## Packaged Sets

SKU	Door Panel Configuration	Pack Qty	Pack Qty Weight (Lb)
PKT-100A-4	1 x 24" door	5	13
PKT-100A-5	1 x 30" door	5	14
PKT-100A-6	1 x 36" door	5	16
PKT-100A-8	1 x 48" door	5	18

Hardware Contents	PKT-100A-4	PKT-100A-5	PKT-100A-6	PKT-100A-8
Track-1601K	47"	59"	71"	95"
4-wheel ball bearing carrier-1606-QR	2	2	2	2
Quick release top mount plate-1800-DBA	2	2	2	2
Door guide-0883	2	2	2	2
Door bumper-0881	1	1	1	1
Wrench-8665-B	1	1	1	1
Screws	Yes	Yes	Yes	Yes

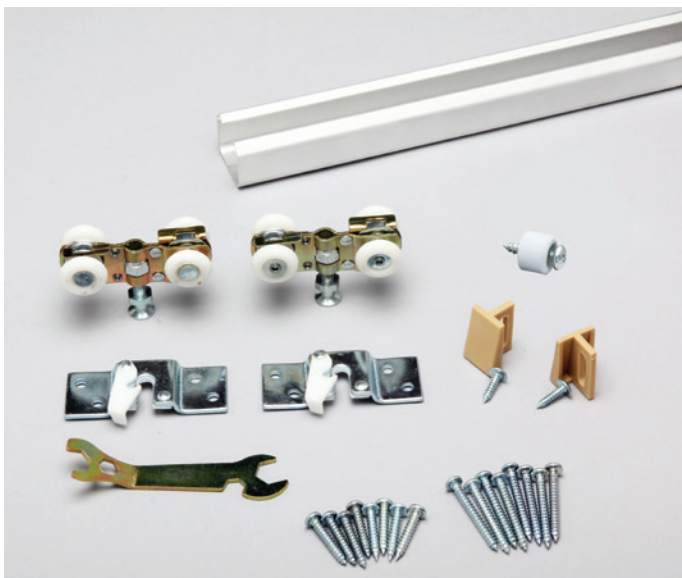

PKT-100A-4

## Tracks

SKU	Description	Pack Qty	Pack Qty Weight (Lb)
BK-1601-47K	47" Aluminum key-holed box track	10	11
BK-1601-59K	59" Aluminum key-holed box track	10	14
BK-1601-71K	71" Aluminum key-holed box track	10	17
BK-1601-96K	96" Aluminum key-holed box track	10	22



BK-1601K Series

## Part Bags

SKU	Door Panels	Pack Qty	Pack Qty Weight (Lb)
PB-PKT-100	1	10	6

Hardware Contents	PB-PKT-100
4-wheel ball bearing carrier-1606-QR	2
Quick release top mount plate-1800-DBA	2
Door guide-0883	2
Door bumper-0881	1
Wrench-8665-B	1
Screws	Yes

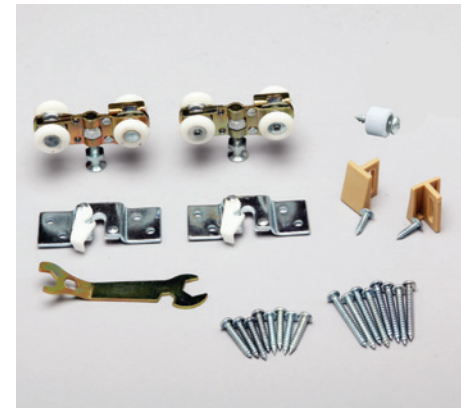

PB-PKT-100

# Components

SKU	Description	Pack Qty	Pack Qty Weight (Lb)
BK-0881	Door bumper	80	1
BK-0883	Pocket door guides	100	2
BK-1353-3.5	Floor plate, jamb spacer 3-1/2"	300	18
BK-1353-4.5	Floor plate, jamb spacer 4-1/2"	150	11
BK-1355	Jamb stiffener 81-3/4"	30	23
BK-1355-85	Jamb stiffener 85-3/4"	30	26
BK-1355-97	Jamb stiffener 97-3/4"	30	30
BK-1606-QR	4-wheel ball bearing carrier, 7/8" diameter wheels	20	4
BK-1800-DBA	Quick release top mount plate	20	1
BN-0868-US10B	2-1/8" finger pull (oil rubbed bronze)	150	5
BN-0868-US15	2-1/8" finger pull (satin nickel)	150	5
BN-0868-US26	2-1/8" finger pull (bright chrome)	150	5
BN-0868-US3	2-1/8" finger pull (bright brass)	150	5
BN-0868-US5	2-1/8" finger pull (antique brass)	150	5
BX1062-26DA	Pocket door lock keyed alike nickel	5	2
BX1062-US26D	Pocket door lock keyed different nickel	5	2
BX1062-US3	Pocket door lock keyed different brass	5	2
BX1062-US3A	Pocket door lock keyed alike brass	5	2
PB-0884-US15	Edge pull (satin nickel)	10	1
PB-0884-US3	Edge pull (bright brass)	10	1
PB-1038-US3	Passage pull (satin nickel)	6	2
PB-1038-US15	Passage pull (bright brass)	6	2
PB-1039-US15	Privacy lock (satin nickel)	6	3
PB-1039-US3	Privacy lock (bright brass)	6	3
PB-1639	Bi-parting door adapter kit	6	4

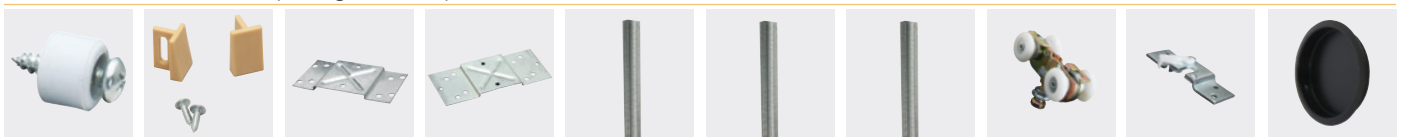

BK-0881 BK-0883 BK-1353-3.5 BK-1353-4.5 BK-1355 BK-1355-85 BK-1355-97 BK-1606-QR BK-1800-DBA BN-0868-US10B



BN-0868-US15 BN-0868-US26 BN-0868-US3 BN-0868-US5 BX1062-26DA BX1062-US26D BX1062-US3 BX1062-US3A PB-0884-US15 PB-0884-US3



PB-1038-US15 PB-1038-US3 PB-1039-US15 PB-1039-US3 PB-1639

# PKT-125A Series



## Aluminum track hardware for 125 lb pocket doors.

Hardware for mid to heavy-weight single pocket doors. The PKT-125A series features a 4-wheel carrier for smooth gliding movement with quick release top mount plate. Ideal for 125 lb pocket doors used in a variety of commercial and residential applications. Bi-parting doors are possible with the optional bi-parting door kit.

- Door thickness: 1-3/8" to 1-3/4"
- Load rating: Up to 125 lbs per door
- Track: Aluminum box track
- Carrier: 4-wheel low friction bearing
- Compares to: Johnson 100PD
- Conforms to: ANSI/BHMA A156.14-2007  
 Grade 1, D8681, D8691, D8692  
 With bi-parting kit - Grade 1, D8711, D8721, D8722

### PKT-125A series configuration

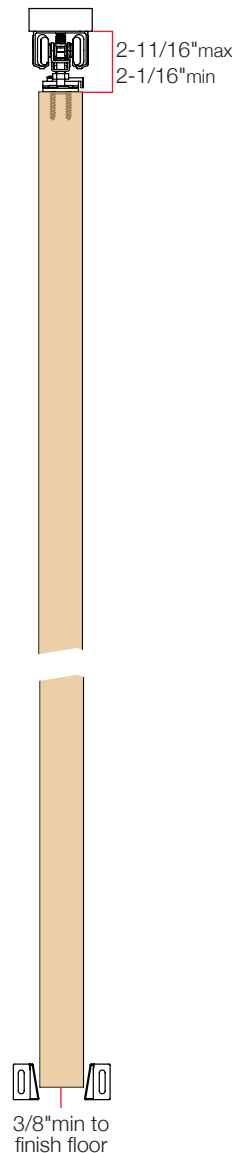
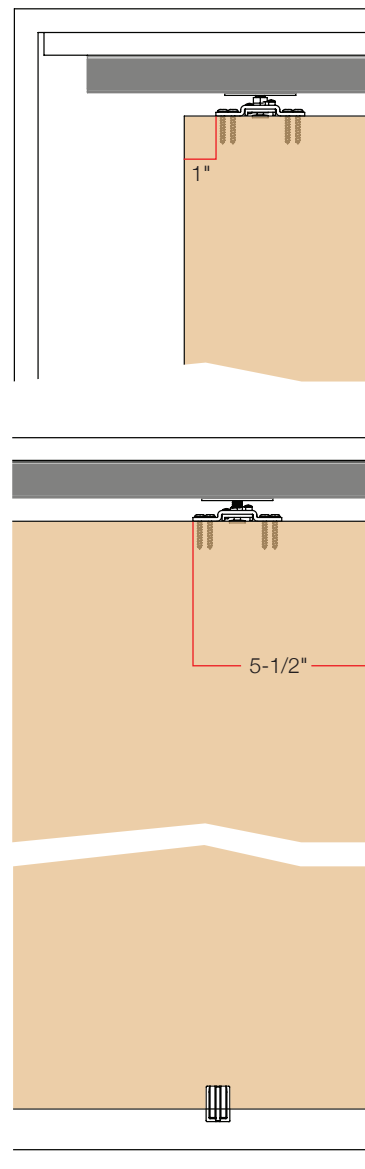
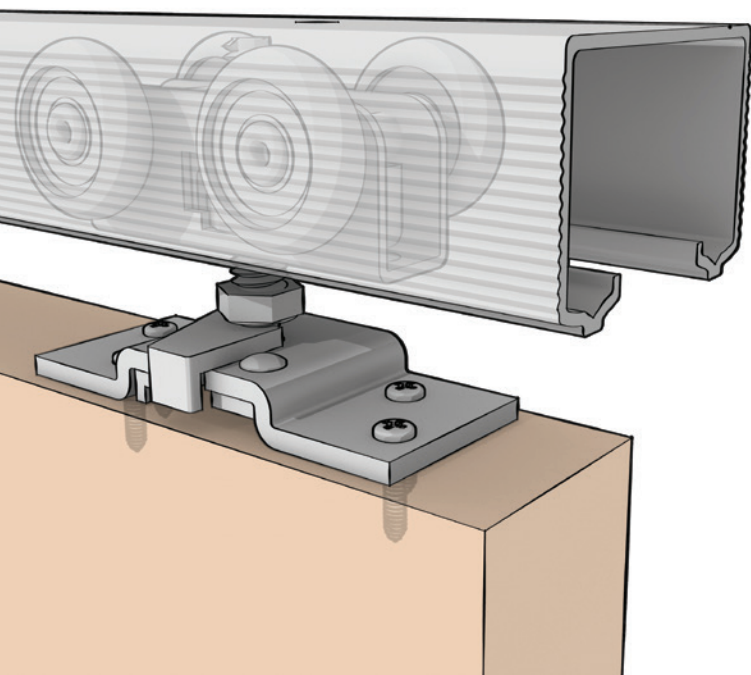

## Packaged Sets

SKU	Door Panel Configuration	Pack Qty	Pack Qty Weight (Lb)
PKT-125A-6	1 x 30" door	5	15

Hardware Contents	PKT-125A-6
Track-2001K	71"
4-wheel carrier-2004	2
Quick release top mount plate-1800-DBA	2
Door guide-0883	2
Door bumper-0881	1
Wrench-8665-B	1
Screws	Yes

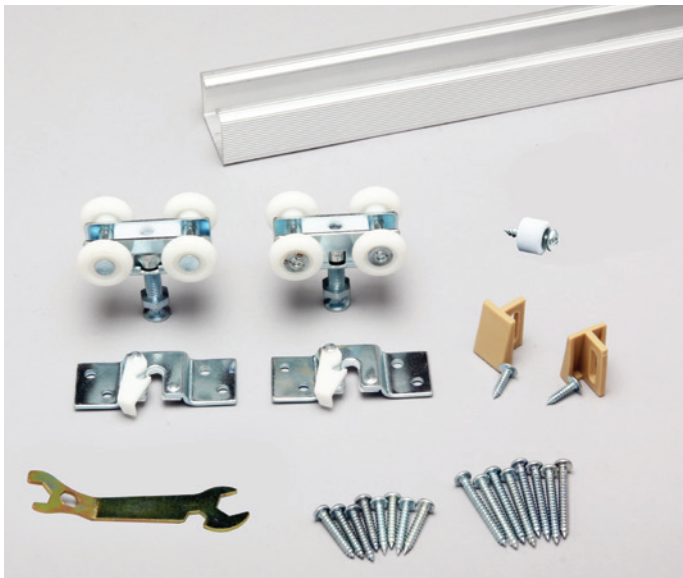

PKT-125A-6



## Tracks

SKU	Description	Pack Qty	Lbs
BK-2001-47K	47" Aluminum key-holed box track	10	12
BK-2001-59K	59" Aluminum key-holed box track	10	17
BK-2001-71K	71" Aluminum key-holed box track	10	22
BK-2001-96K	96" Aluminum key-holed box track	10	28



**BK-2001K Series**

## Part Bags

SKU	Door Panels	Pack Qty	Pack Qty Weight (Lb)
PB-PKT-125	2	10	6

Hardware Contents	PB-PKT-125
4-wheel carrier-2004	2
Quick release top mount plate-1800-DBA	2
Door guide-0883	2
Door bumper-0881	1
Wrench-8665-B	1
Screws	Yes

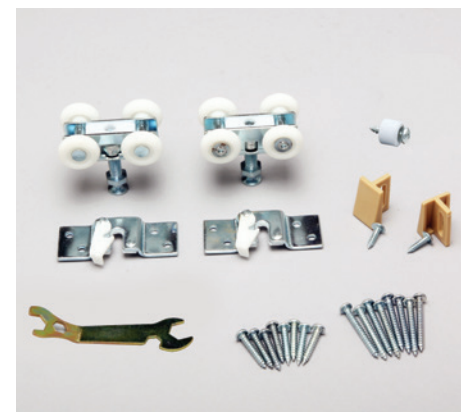

**PB-PKT-125**

# Components

SKU	Description	Pack Qty	Pack Qty Weight (Lb)
BK-0881	Door bumper	80	1
BK-0883	Pocket door guides	100	2
BK-1353-3.5	Floor plate, jamb spacer 3-1/2"	300	18
BK-1353-4.5	Floor plate, jamb spacer 4/-1/2"	150	11
BK-1355	Jamb stiffener 81-3/4"	30	23
BK-1355-85	Jamb stiffener 85-3/4"	30	26
BK-1355-97	Jamb stiffener 97-3/4"	30	30
BX1062-26DA	Pocket door lock keyed alike nickel	5	2
BX1062-US26D	Pocket door lock keyed different nickel	5	2
BX1062-US3	Pocket door lock keyed different brass	5	2
BX1062-US3A	Pocket door lock keyed alike brass	5	2
PB-0884-US15	Edge pull (satin nickel)	10	1
PB-0884-US3	Edge pull (bright brass)	10	1
PB-1038-US3	Passage pull (satin nickel)	6	2
PB-1038-US15	Passage pull (bright brass)	6	2
PB-1039-US15	Privacy lock (satin nickel)	6	3
PB-1039-US3	Privacy lock (bright brass)	6	3
PB-1639	Bi-parting door adapter kit	6	4
PB-2004	4-wheel carrier, 1" diameter wheels with quick release top mount plate	120	6



BK-0881 BK-0883 BK-1353-3.5 BK-1353-4.5 BK-1355 BK-1355-85 BK-1355-97 BX1062-26DA BX1062-US26D BX1062-US3

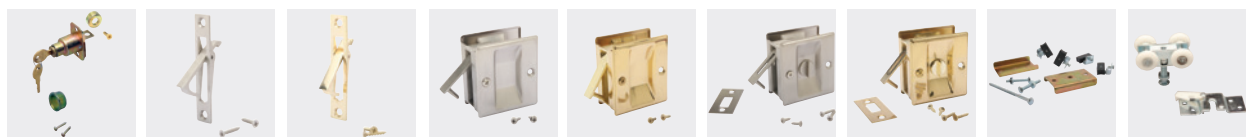

BX1062-US3A PB-0884-US15 PB-0884-US3 PB-1038-US15 PB-1038-US3 PB-1039-US15 PB-1039-US3 PB-1639 PB-2004

# PKT-150A Series



## Aluminum track hardware for 150 lb pocket doors.

Hardware for heavy-weight single pocket doors. The PKT-150A series features a 4-wheel ball bearing carrier with quick release top mount plate for smooth gliding movement. Ideal for 150 lb pocket doors used in a variety of commercial and residential applications. Bi-parting doors are possible with the optional bi-parting door kit.

- Door thickness: 1-3/8" to 1-3/4"
- Load rating: Up to 150 lbs per door
- Track: Aluminum box track
- Carrier: 4-wheel ball bearing
- Compares to: Hettich/Grant 71-034, 71-111, 71-138, 71-222, 150, 5150, Johnson IIIPD, Stanley PD150
- Conforms to: ANSI/BHMA A156.14-2007 Grade 1, D8681, D8691, D8692  
 With bi-parting kit - Grade 1, D8711, D8721, D8722

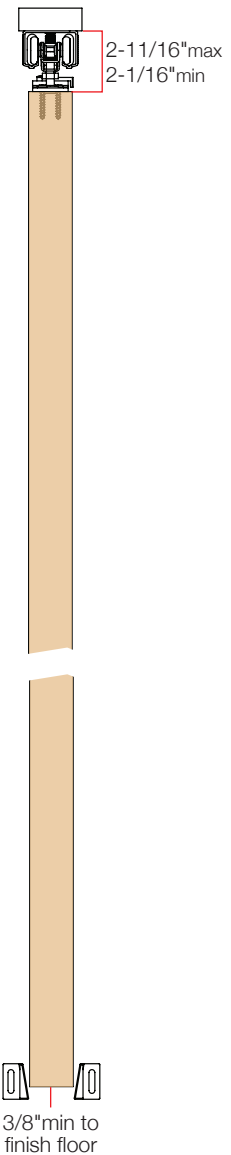
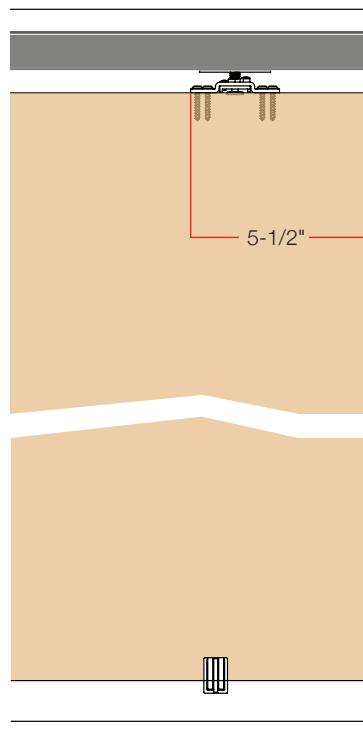
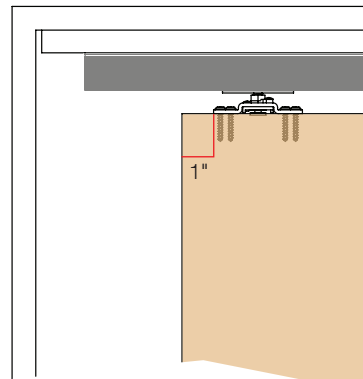

### PKT-150A series configuration

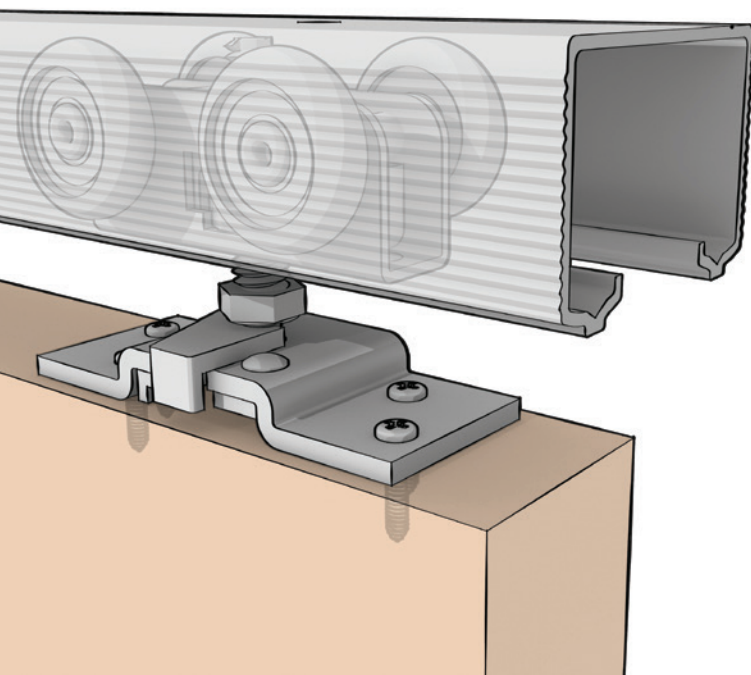

## Packaged Sets

SKU	Door Configuration Panel	Pack Qty	Pack Qty Weight (Lb)
PKT-150A-6	1 x 36" door	5	15

Hardware Contents	PKT-150A-6
Track-2001K	71"
4-wheel ball bearing carrier-2004-BB	2
Quick release top mount plate-1800-DBA	2
Door guide-0883	2
Door bumper-0881	1
Wrench-8665-B	1
Screws	Yes

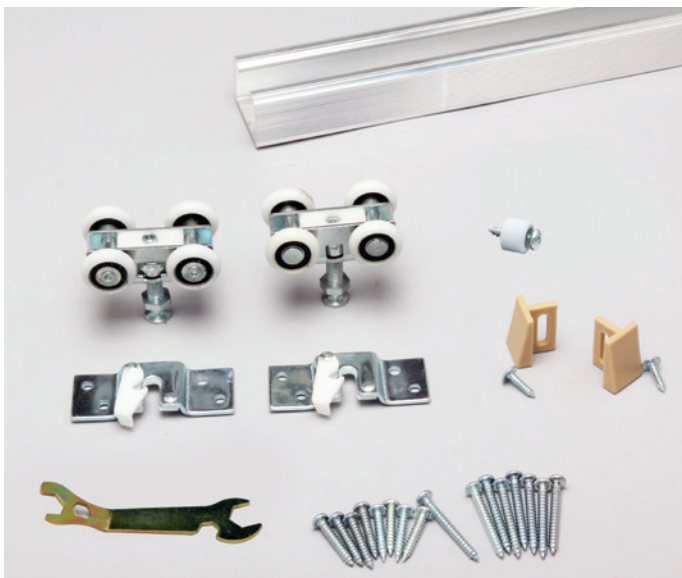

PKT-150A-6

## Tracks

SKU	Description	Pack Qty	Lbs
BK-2001-47K	47" Aluminum key-holed box track	10	12
BK-2001-59K	59" Aluminum key-holed box track	10	17
BK-2001-71K	71" Aluminum key-holed box track	10	22
BK-2001-96K	96" Aluminum key-holed box track	10	28

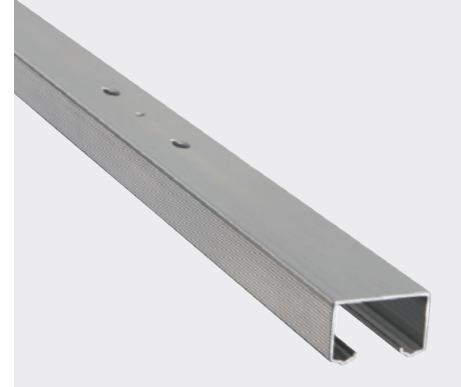

BK-2001K Series

## Part Bags

SKU	Door Panels	Pack Qty	Pack Qty Weight (Lb)
PB-PKT-150	1	10	6

Hardware Contents	PB-PKT-150
4-wheel ball bearing carrier-2004-BB	2
Quick release top mount plate-1800-DBA	2
Door guide-0883	2
Door bumper-0881	1
Wrench-8665-B	1
Screws	Yes



PB-PKT-150

# Components

SKU	Description	Pack Qty	Pack Qty Weight (Lb)
BK-0881	Door bumper	80	1
BK-0883	Pocket door guides	100	2
BK-1353-3.5	Floor plate, jamb spacer 3-1/2"	300	18
BK-1353-4.5	Floor plate, jamb spacer 4/-1/2"	150	11
BK-1355	Jamb stiffener 81-3/4"	30	23
BK-1355-85	Jamb stiffener 85-3/4"	30	26
BK-1355-97	Jamb stiffener 97-3/4"	30	30
BX1062-26DA	Pocket door lock keyed alike nickel	5	2
BX1062-US26D	Pocket door lock keyed different nickel	5	2
BX1062-US3	Pocket door lock keyed different brass	5	2
BX1062-US3A	Pocket door lock keyed alike brass	5	2
PB-0884-US15	Edge pull (satin nickel)	10	1
PB-0884-US3	Edge pull (bright brass)	10	1
PB-1038-US3	Passage pull (satin nickel)	6	2
PB-1038-US15	Passage pull (bright brass)	6	2
PB-1039-US15	Privacy lock (satin nickel)	6	3
PB-1039-US3	Privacy lock (bright brass)	6	3
PB-1639	Bi-parting door adapter kit	6	4
PB-2004-BB	4-wheel ball bearing carrier, 1" diameter wheels with quick release top mount plate	10	3

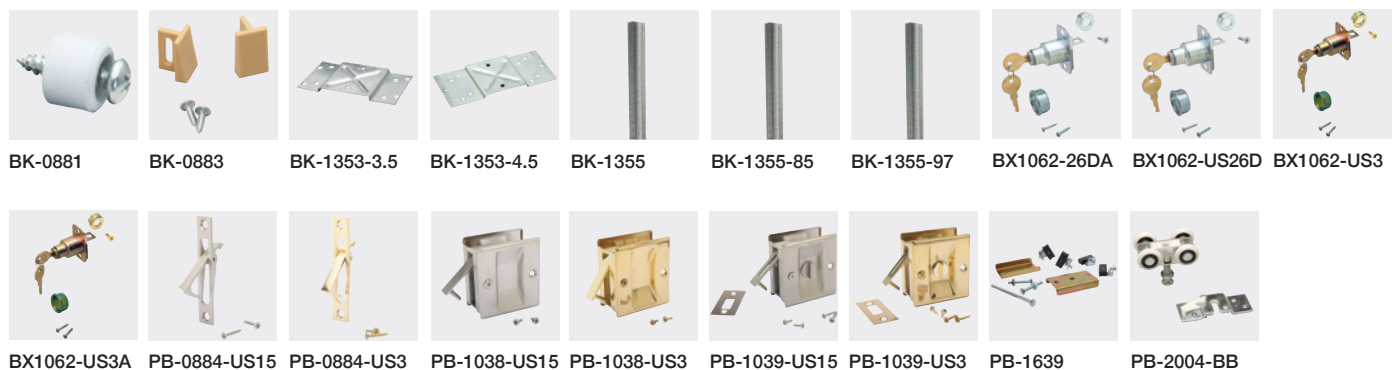

# PKT-250A Series

## Aluminum track hardware for 250 lb pocket doors.

Classic hardware for ultra heavy-weight single pocket doors. The PKT-250A series features a 4-wheel ball bearing carrier and quick release top mount plate for smooth and sturdy gliding movement. Ideal for 250 lb pocket doors used in a variety of commercial and residential applications. Bi-parting doors are possible with the optional bi-parting door kit.

Door thickness:	1-3/8" to 1-3/4"
Load rating:	Up to 250 lbs per door
Track:	Aluminum box track
Carrier:	4-wheel ball bearing
Compares to:	Hettich/Grant 1210, Johnson 100PD, 200PD
Conforms to:	ANSI/BHMA A156.14-2007 Grade 1, D8681, D8691, D8692 With bi-parting kit - Grade 1, D8711, D8721, D8722

### PKT-250A series configuration

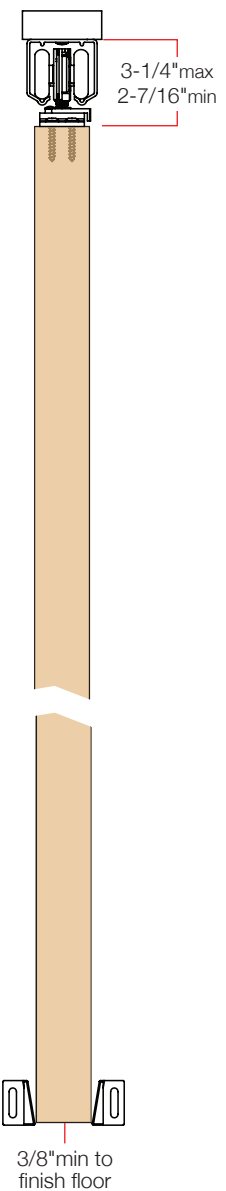
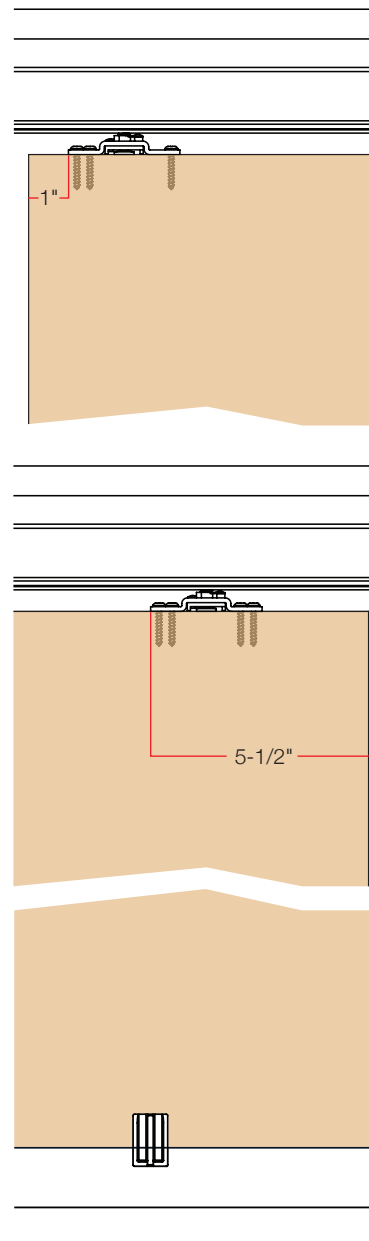
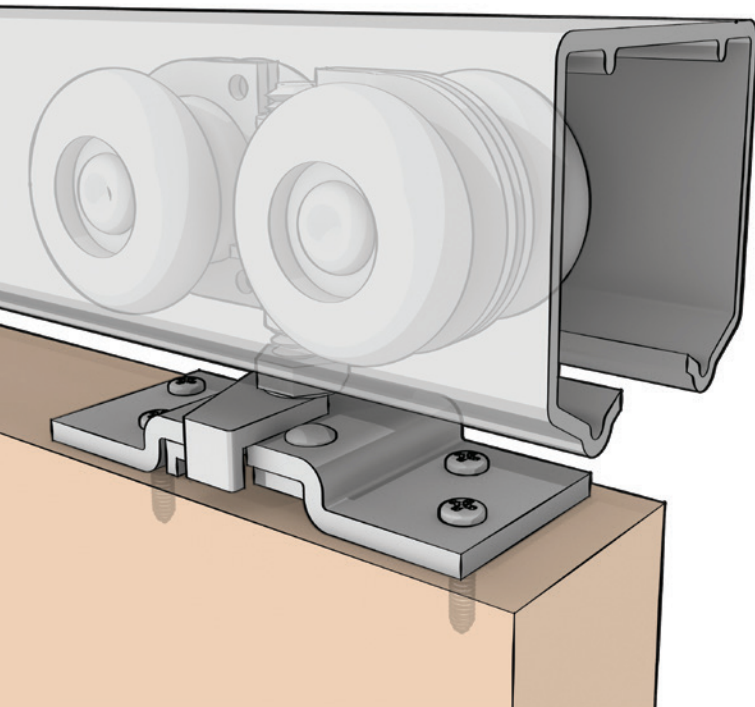

## Packaged Sets

SKU	Door Panel Configuration	Pack Qty	lbs
PKT-250A-6	1 x 36" door	5	25
PKT-250A-8	1 x 48" door	5	37

Hardware Contents	PKT-250A-6	PKT-250A-8
Track-1801K	72"	96"
4-wheel ball bearing carrier-1820	2	2
Quick release top mount plate-1800-DBA	2	2
Door guide-0883	2	2
Door bumper-0881	1	1
Wrench-8710	1	1
Screws	Yes	Yes



PKT-250A-6



## Tracks

SKU	Description	Pack Qty	Lbs
BK-1801-48K	48" Aluminum key-holed box track	5	6
BK-1801-60K	60" Aluminum key-holed box track	5	9
BK-1801-72K	72" Aluminum key-holed box track	5	14
BK-1801-96K	96" Aluminum key-holed box track	5	19



**BK-1801K Series**

## Part Bags

SKU	Door Panels	Pack Qty	Lbs
PB-PKT-250	1	10	6

Hardware Contents	PB-PKT-250
4-wheel ball bearing carrier-1820	2
Quick release top mount plate-1800-DBA	2
Door guide-0883	2
Door bumper-0881	1
Wrench-8710	1
Screws	Yes



**PB-PKT-250**

## Components

SKU	Description	Pack Qty	Lbs
BK-0881	Door bumper	80	1
BK-0883	Pocket door guides	100	2
BK-1353-3.5	Floor plate, jamb spacer 3-1/2"	300	18
BK-1353-4.5	Floor plate, jamb spacer 4-1/2"	150	11
BK-1355	Jamb stiffener 81-3/4"	30	23
BK-1355-85	Jamb stiffener 85-3/4"	30	26
BK-1355-97	Jamb stiffener 97-3/4"	30	30
BK-1800-DBA	Quick release top mount plate	20	2
BK-1820	4-wheel ball bearing carrier with 1-1/4" diameter wheels	20	2
BX1062-26DA	Pocket door lock keyed alike nickel	5	2
BX1062-US26D	Pocket door lock keyed different nickel	5	2
BX1062-US3	Pocket door lock keyed different brass	5	2
BX1062-US3A	Pocket door lock keyed alike brass	5	2
PB-0884-US15	Edge pull (satin nickel)	10	1
PB-0884-US3	Edge pull (bright brass)	10	1
PB-1038-US15	Passage pull (bright brass)	6	2
PB-1038-US3	Passage pull (satin nickel)	6	2
PB-1039-US15	Privacy lock (satin nickel)	6	3
PB-1039-US3	Privacy lock (bright brass)	6	3
PB-1639	Bi-Parting door adapter kit	6	4



# POCKET COMPONENTS



- BK-0881 Bumper**
- **Materials:** Plastic
  - **Dimension:** 1/2"
  - **Notes:** Includes screw. Is adhered to back end of door.



- BK-1355 Jamb stiffener**
- **Materials:** Galvanized steel
  - **Length:** 81-3/4"



- BK-0883-WT Pocket door guides**
- **Materials:** Plastic
  - **Guide:** 1-3/16" x 3/4" x 1-1/8" (21mm x 19mm x 29mm)
  - **Notes:** Two guides needed per door. Screws to jamb door guide. White.



- BK-1355-85 Jamb stiffener**
- **Materials:** Galvanized steel
  - **Length:** 85"

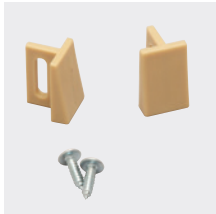

- BK-0883 Pocket door guides**
- **Materials:** Plastic
  - **Guide:** 1-3/16" x 3/4" x 1-1/8" (21mm x 19mm x 29mm)
  - **Notes:** Two guides needed per door. Screws to jamb door guide. Beige.



- BK-1355-97 Jamb stiffener**
- **Materials:** Galvanized steel
  - **Length:** 97"



- BK-0889 Pocket door guide**
- **Materials:** Plastic
  - **Notes:** Screws to jamb door guide. White.



- BK-1507-TM Top mount plate**
- **Materials:** Steel with brass finish



- BK-1353-3.5 Floor plate, jamb spacer**
- **Materials:** Galvanized steel
  - **Length:** 3-1/2"



- BK-1582 4-Wheel ball bearing carrier**
- **Materials:** Steel
  - **Wheel:** 7/8" (22mm) diameter
  - **Notes:** Wheels self-align to allow consistent contact with track. Lubricated plastic wheels on steel shafts.



- BK-1353-4.5 Floor plate, jamb spacer**
- **Materials:** Galvanized steel
  - **Length:** 4-1/2"



- BK-1606-QR 4-Wheel ball bearing carrier**
- **Materials:** Steel with brass finish
  - **Wheel:** 7/8" (22mm) diameter
  - **Notes:** Wheels self-align to allow consistent contact with track. Lubricated plastic wheels on steel shafts.



- BK-1800-DBA** Quick release top mount plate
- **Materials:** Zinc plated steel with plastic lever
  - **Notes:** Attaches to door. Carrier attaches to plate. Quick release feature.



- BN-0868-US5** Pull
- **Finish:** Antique brass
  - **Diameter:** 2-1/8"



- BK-1820** 4-Wheel ball bearing carrier
- **Materials:** Zinc plated steel
  - **Wheel:** 1-1/4" (32mm) diameter
  - **Notes:** Wheels self-align to allow consistent contact with track. Lubricated plastic wheels on steel shafts.



- BX1062-26DA** Lock
- **Materials:** Steel
  - **Notes:** Nickel, keyed alike



- BN-0868-US10B** Pull
- **Finish:** Oil rubbed bronze
  - **Diameter:** 2-1/8"



- BX1062-US26D** Lock
- **Materials:** Steel
  - **Notes:** Nickel, keyed different (5 key random)



- BN-0868-US15** Pull
- **Finish:** Satin nickel
  - **Diameter:** 2-1/8"

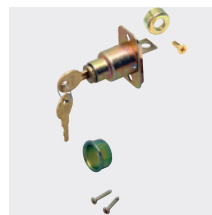

- BX1062-US3** Lock
- **Materials:** Steel
  - **Notes:** Brass, keyed different (5 key random)



- BN-0868-US26** Pull
- **Finish:** Bright chrome
  - **Diameter:** 2-1/8"

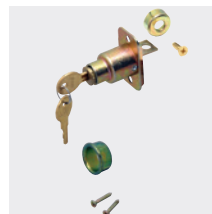

- BX1062-US3A** Lock
- **Materials:** Steel
  - **Notes:** Brass, keyed alike



- BN-0868-US3** Pull
- **Finish:** Bright brass
  - **Diameter:** 2-1/8"



- PB-0884-US15** Edge pull
- **Extends:** 1-1/16" (27 mm)
  - **Faceplate:** 21/32" x 3-1/2" (17mm x 89mm)
  - **Notes:** Satin nickel. Includes two screws. Ideal for narrow and standard door thicknesses.



**PB-0884-US3** Edge pull

- **Extends:** 1-1/16" (27 mm)
- **Faceplate:** 21/32" x 3-1/2" (17mm x 89mm)
- **Notes:** Bright brass. Includes two screws. Ideal for narrow and standard door thicknesses.



**PB-1639** Bi-parting door adapter kit

- **Notes:** For PKT-100A, PKT-125A, PKT-150A, PKT-250A



**PB-1038-US15** Pocket door latch

- **Size:** 2-3/4" x 2-1/2" (70mm x 64mm)
- **Finish:** Satin nickel
- **Fasteners:** Included
- **Notes:** For use with 1-3/8" to 1-3/4" (35mm x 45mm) doors.



**PB-2004** 4-Wheel carrier and quick release top mount plate

- **Materials:** Zinc plated steel and plastic
- **Wheel:** 1" (25mm) diameter
- **Notes:** Wheels self-align for consistent contact with track. Lubricated plastic wheels.



**PB-1038-US3** Pocket door latch

- **Size:** 2-3/4" x 2-1/2" (70mm x 64mm)
- **Finish:** Bright brass
- **Fasteners:** Included
- **Notes:** For use with 1-3/8" to 1-3/4" (35mm x 45mm) doors.



**PB-2004-BB** 4-Wheel ball bearing carrier and quick release top mount plate

- **Materials:** Zinc plated steel and plastic
- **Wheel:** 1" (25mm) diameter
- **Notes:** Wheels self-align for consistent contact with track. Lubricated plastic wheels.



**PB-1039-US15** Pocket door privacy latch

- **Size:** 2-3/4" x 2-1/2" (70mm x 64mm)
- **Finish:** Satin nickel
- **Fasteners:** Included
- **Notes:** For use with 1-3/4" (45mm) doors.



**PB-1039-US3** Pocket door privacy latch

- **Size:** 2-3/4" x 2-1/2" (70mm x 64mm)
- **Finish:** Bright brass
- **Fasteners:** Included
- **Notes:** For use with 1-3/4" (45mm) doors.



**PB-1437** Bi-parting door adapter kit

- **Notes:** For PKT-75S, PKT-75A.

# POCKET CROSS-REFERENCE

KV Series	Hettich/Grant	Johnson	Stanley
PKT-75S   75A	6023, 6053	2800, 2850, 111PD	PD75
PKT-100A	-	IIIIPD, 2800, 2850	-
PKT-125A	-	100PD	-
PKT-150A	71-034, 71-111, 71-138, 71-222, 150, 5150	111PD	PD150
PKT-250A	1210	100PD, 200PD	-





# POCKET FRAMES



**Durable door frame kits for pocket doors.  
Simple to install. Built to last.**

Knapé and Vogt offers a full range of frame kits for simple installations of 75 lb to 250 lb pocket doors.

Pocket Frame Overview . . . . .	136
PKF-75S . . . . .	138
PKF-100A   100A7   100A8   100A6W . . . . .	140
PKF-150A   150A7   150A8   150A6W . . . . .	142
PKF-250A . . . . .	144
Components . . . . .	146
Competitor Cross-Reference . . . .	147



# POCKET FRAME OVERVIEW

## PKF POCKET FRAME

### Naming Structure

PKF-100A6W-3

①	②	③	④	⑤	⑥
Pocket Frame Kit	Door Weight	Track Type	Height	Width	Passage Width
PKF	75	S (Steel)	6 (6'8")	W (6")	3'
	100	A (Aluminum)	7 (7')		4'
	150		8 (8')		
	250				

BK = Bulk  
PB = Part Bag

### Ordering Instructions

Once the series of sliding door hardware has been identified by confirming your project's door weight and the door thickness, the next step is to go to the series page.

Pocket frame kits include all the framing and hardware components to make installing pocket doors easy. Pocket door hardware includes a woodnailer/header, split studs and floor plates.

KV offers frame kit solutions for traditional 2" x 4" framing, as well as 2" x 6" framing applications.

Simply choose the frame kit that best suits your needs. Everything you would need to install it is shipped complete.

## Series Overview Matrix

		POCKET FRAME									
		PKF-75S	PKF-100A	PKF-100A7	PKF-100A8	PKF-100A6W*	PKF-150A	PKF-150A7	PKF-150A8	PKF-150A6W*	PKF-250A
Light	20 lb										
	30 lb										
	50 lb										
Standard	60 lb										
	75 lb	•									
	100 lb		•	•	•	•					
Heavy Duty	125 lb										
	150 lb						•	•	•	•	
	175 lb										
	250 lb										•
	275 lb										
Track		1599	1601K	1601K	1601K	1601K	2001K	2001K	2001K	2001K	1801K
Steel		•									
Aluminum			•	•	•	•	•	•	•	•	•
Fascia											
Non-Fascia		•	•	•	•	•	•	•	•	•	•
Type	Box	•	•	•	•	•	•	•	•	•	•
	Double J										
	I-Beam										
Min. Door Thickness	3/4"										
	7/8"										
	1"										
	1-1/8"										
	1-3/8"	•	•	•	•	•	•	•	•	•	•
	1-3/4"	•	•	•	•	•	•	•	•	•	•
Carrier		1572-N 4-wheel	1606-QR 4-wheel BB	1606-QR 4-wheel BB	1606-QR 4-wheel BB	1606-QR 4-wheel BB	2004-BB 4-wheel	2004-BB 4-wheel	2004-BB 4-wheel	2004-BB 4-wheel	1820 4-wheel BB

This product overview matrix shows the four hardware series in Knappe and Vogt's pocket frame category. Using the matrix, you can compare each series to help you choose the one that will fit best within your project. Go to the series pages for more in-depth information including tracks, parts bags and components.

\* 6W refers to walls with 2" x 6" framing. All other models support traditional 2" x 4" framing.

75 100 150 250

Pocket Door Weight (lbs.)

Door Thickness:

1-3/8" - 1-3/4"

PKF-75S

PKF-100A | 100A7 | 100A8 | 100A6W

PKF-150A | 150A7 | 150A8 | 150A6W

PKF-250A

Components

# PKF-75S Series

## Pocket frame hardware for 75 lb pocket doors.



Durable pocket frame kit for medium-weight single pocket doors, 6'8" with traditional 2" x 4" framing. The PKF-75S features 4-wheel carriers with top mount plates and sturdy track-end and doorway-end brackets. Ideal for 75 lb pocket doors used in a variety of residential applications. Bi-parting doors are possible with the optional bi-parting door kit.

Door thickness: 1-3/8" to 1-3/4"

Door Height: 6'8"

Load rating: Up to 75 lbs per door

Track: Steel box track

Carrier: 4-wheel low friction bearing

Compares to: Johnson 1500

Conforms to: ANSI/BHMA A156.14-2007  
Grade 2, D8672

With bi-parting kit - Grade 1, D8721, D8722

### PKF-75S series configuration

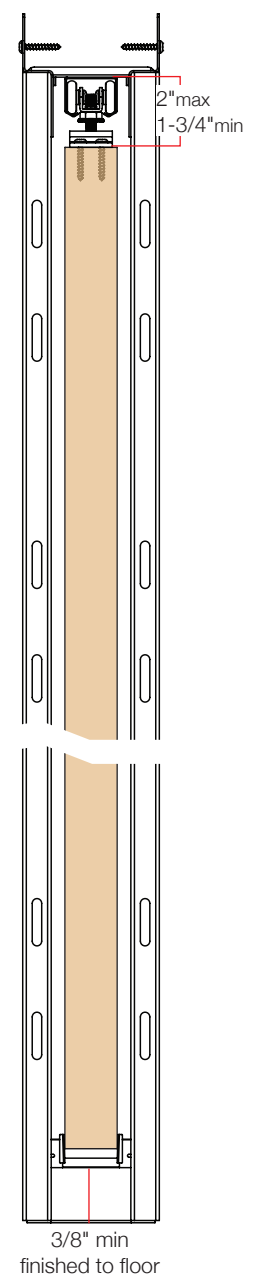
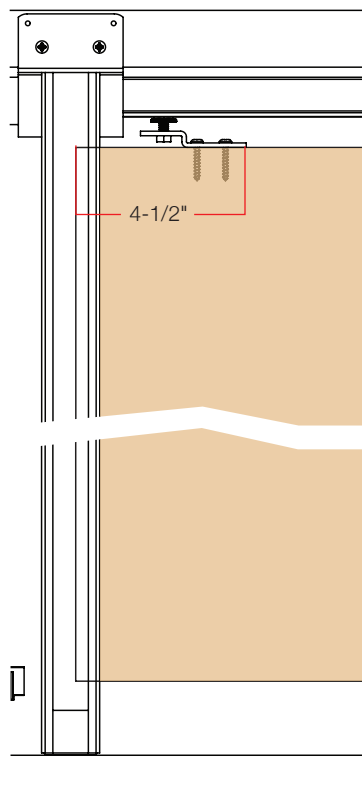
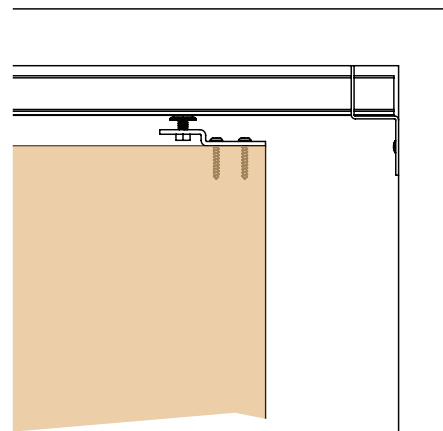
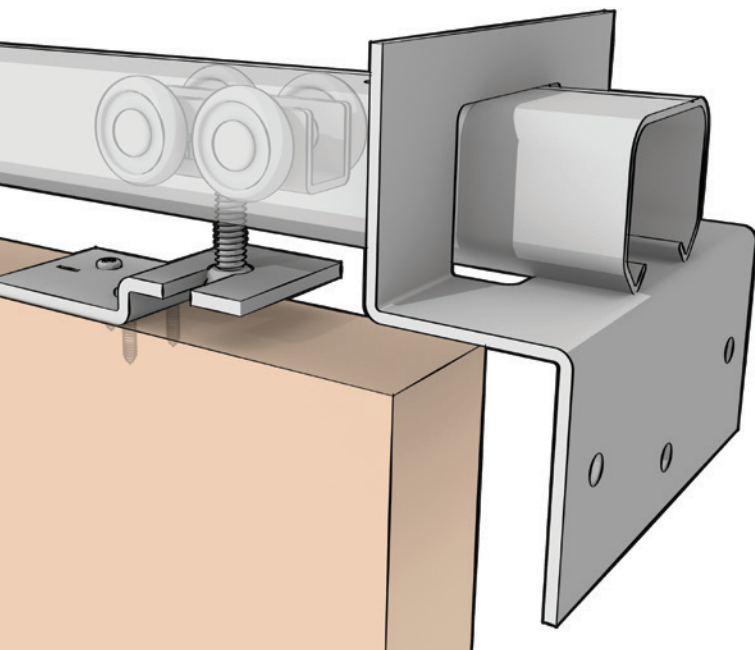

# Frame Kit

SKU	Door Panel Configuration	Pack Qty	Pack Qty Weight (Lb)
PKF-75S-3	Door width up to 36"	1	26

Frame Kit Contents	PKF-75S-3
Nailer with 1599 steel track	1
Doorway end bracket-8661	1
Track end bracket-6805	1
Floor plate-8931	2
Split studs	4
4-wheel carrier-1572-N	2
Top mount plate-1507-TM	2
Door guide-0889	1
Door bumper-0881	1
Wrench-8665-B	1
Screws	Yes

Contents of Adaptor Kit for 1-3/4" thick doors	Qty
Floor plate-1840-FP	2
Wood shim-1634-WS	4
Finishing nail-1634-NAIL	8

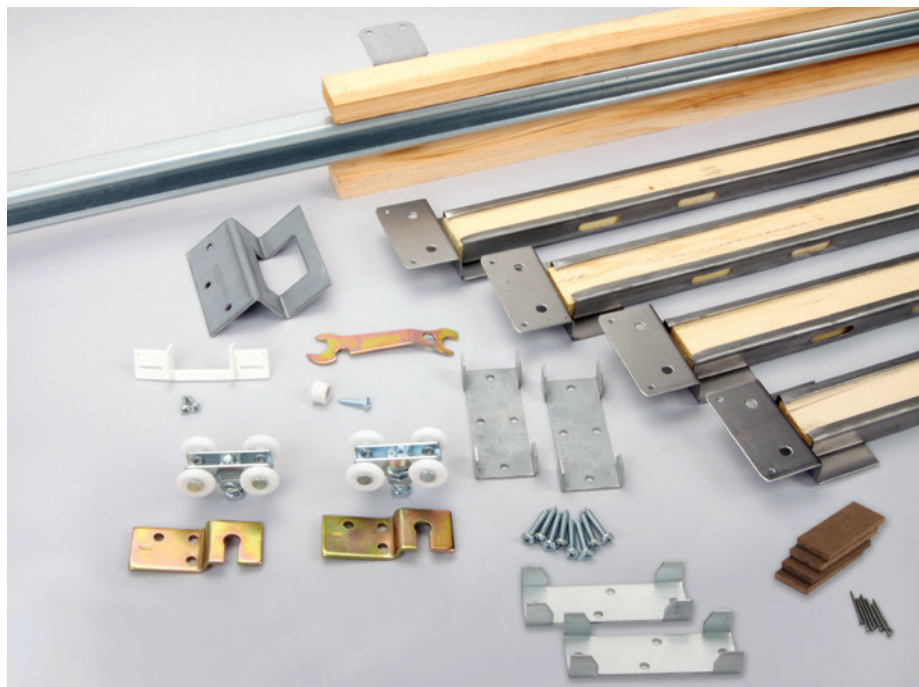

**PKF-75S**

# PKF-100 Series

## Pocket frame hardware for 100 lb pocket doors.

Durable pocket frame kit for mid to heavy-weight single pocket doors with 6'8", 7', or 8' heights. The PKF-100 series features 4-wheel carriers with quick release top mount plates and sturdy track-end and doorway-end brackets. Ideal for 100 lb pocket doors used in a variety of residential applications. Bi-parting doors are possible with the optional bi-parting door kit.

Door thickness: 1-3/8" to 1-3/4"

Door height: 6'8", 7', 8'

Load rating: Up to 100 lbs per door

Track: Aluminum box track

Carrier: 4-wheel ball bearing

Compares to: Johnson 1500

Conforms to: ANSI/BHMA A156.14-2007  
Grade 1, D8671, D8672

With bi-parting kit - Grade 1, D8721, D8722

### PKF-100 series configuration

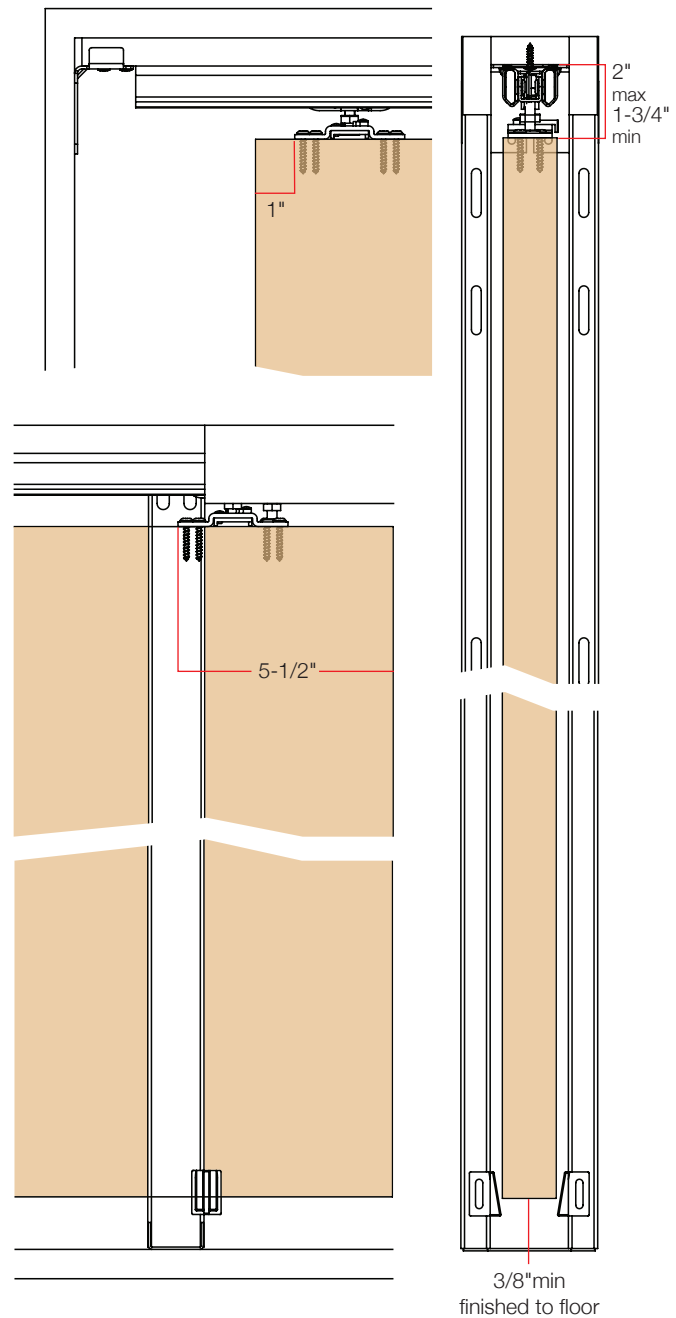
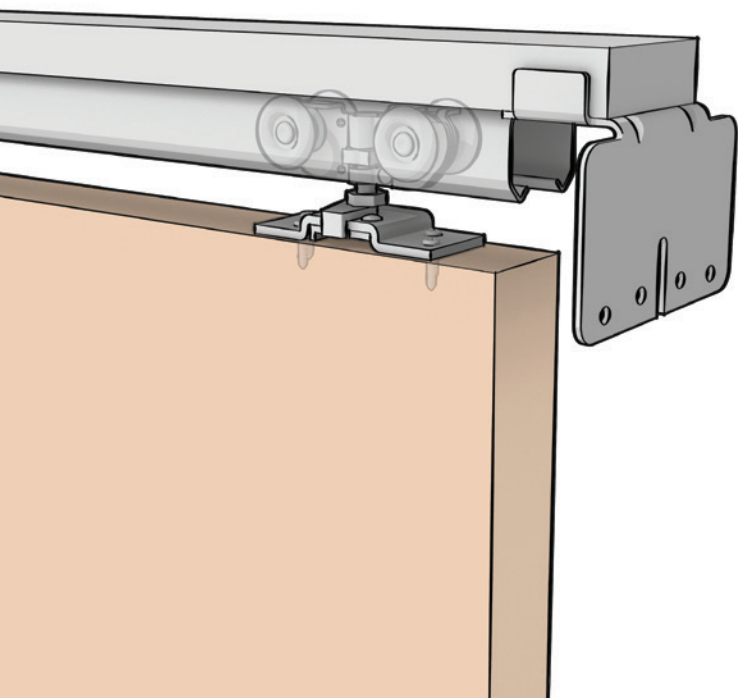

## Frame Kit

SKU	Door Panel Configuration	Pack Qty	Pack Qty Weight (Lb)
PKF-100A-3	Door widths up to 36"	1	29
PKF-100A7-3	Door widths up to 36"	1	30
PKF-100A8-3	Door widths up to 36"	1	35
PKF-100A6W-3*	Door widths up to 36"	1	30

\* For 2" x 6" framing.

Frame Kit Contents	PKT-100A-3	PKF-100A7-3	PKF-100A8-3	PKF-100A6W3
Header with 1601K aluminum track	72"	72"	72"	72"
Doorway end bracket-8661	1	1	1	1
Pocket end bracket-8662	1	1	1	1
Floor plate-8931	2	2	2	-
Floor plate-1636-FP	-	-	-	2
Door bumper-0881	1	1	1	1
Carrier-1606-QR with quick release top mount plate-1800-DBA	2	2	2	2
Split studs	4 x 6'8"	4 x 7'	4 x 8'	4 x 6'8"
Door guides-0883	2	2	2	2
Wrench-8665-B	1	1	1	1
Screws	Yes	Yes	Yes	Yes

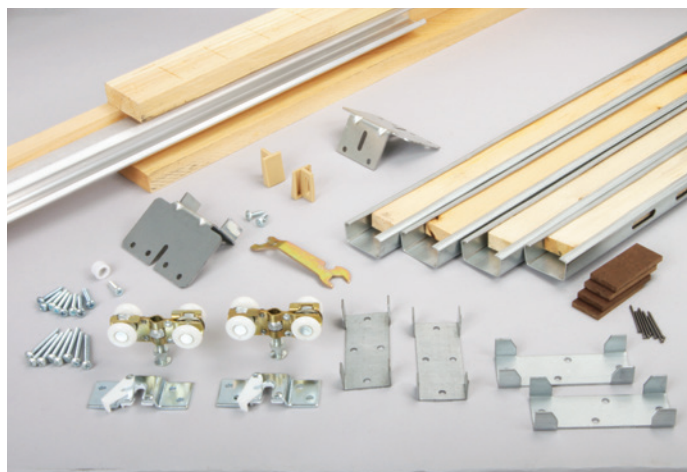

PKF-100A

Contents of Adaptor Kit for 1-3/4" thick doors	Qty
Floor plate-1840-FP	2
Wood shim-1634-WS	4
Finishing nail-1634-NAIL	8

Note: PKF-100AW6-3 supports 2" x 6" construction so adaptor kit is not included.

# PKF-150 Series

## Pocket frame hardware for 150 lb pocket doors.

Durable pocket frame kit for heavy-weight single pocket doors with 6'8", 7', or 8' heights. The PKF-150 series features 4-wheel ball bearing carriers with quick release top mount plates and sturdy track-end and doorway-end brackets. Ideal for 150 lb pocket doors used in a variety of commercial and residential applications. Bi-parting doors are possible with the optional bi-parting door kit.

Door thickness: 1-3/8" to 1-3/4"

Door height: 6'8", 7', 8'

Load rating: Up to 150 lbs per panel (bi-fold)

Track: Aluminum box track

Carrier: 4-wheel ball bearing

Compares to: Johnson 1500, Stanley PDF150N

Conforms to: ANSI/BHMA A156.14-2007  
Grade 1, D8671, D8672

With bi-parting kit - Grade 1, D8711, D8721, D8722

### PKF-150 series configuration

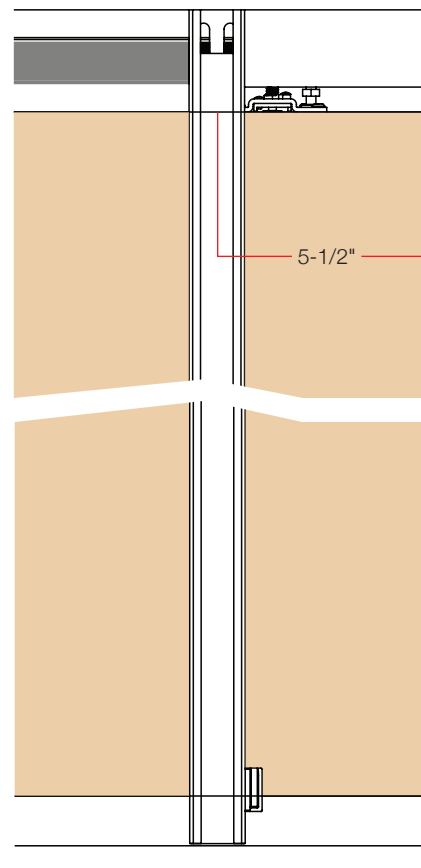
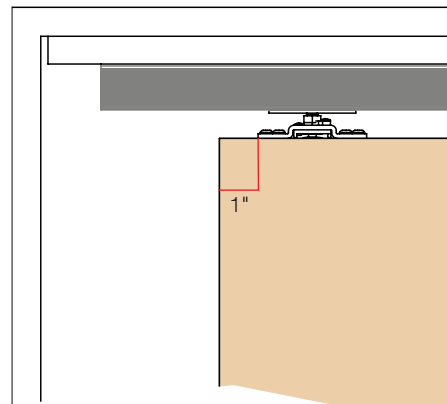
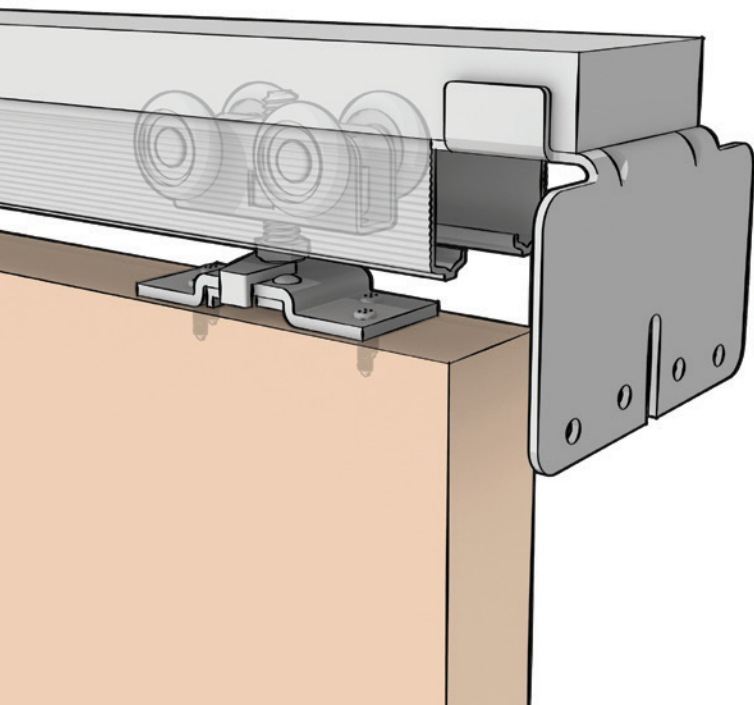

2-11/16"  
max  
2-1/16"  
min

3/8" min  
finished to floor

## Frame Kit

SKU	Door Panel Configuration	Pack Qty	Pack Qty Weight (Lb)
PKF-150A-3	Door widths up to 36"	1	29
PKF-150A7-3	Door widths up to 36"	1	30
PKF-150A8-3	Door widths up to 36"	1	35
PKF-150A6W-3*	Door widths up to 36"	1	30

\* For 2" x 6" framing.

Frame Kit Contents	PKT-150A-3	PKF-150A7-3	PKF-150A8-3	PKF-150A6W3
Header with 2001K aluminum track	72"	72"	72"	72"
Doorway end bracket-8661	1	1	1	1
Pocket end bracket-8662	1	1	1	1
Floor plate-8931	2	2	2	-
Floor plate-1636-FP	-	-	-	2
Door bumper-0881	1	1	1	1
Carrier-2004-BB with quick release top mount plate-1800-DBA	2	2	2	2
Split studs	4 x 6'8"	4 x 7'	4 x 8'	4 x 6'8"
Door guides-0883	2	2	2	2
Wrench-8665-B	1	1	1	1
Screws	Yes	Yes	Yes	Yes

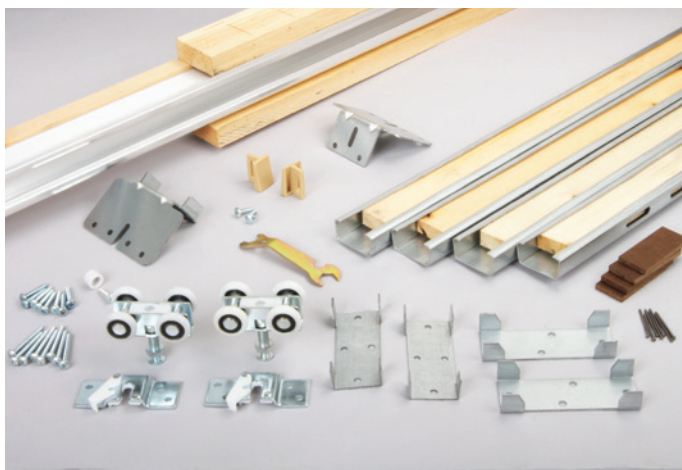

PKF-150

Contents of Adaptor Kit for 1-3/4" thick doors	Qty
Floor plate-1840-FP	2
Wood shim-1634-WS	4
Finishing nail-1634-NAIL	8

Note: PKF-150AW6-3 supports 2" x 6" construction so adaptor kit is not included.



# PKF-250A Series

## Pocket frame hardware for 250 lb pocket doors.

Durable pocket frame kit for ultra heavy-weight single pocket doors, 8' tall with 2" x 4" framing. The PKF-250A features 4-wheel carriers with quick release top mount plates and sturdy pocket-end and doorway-end brackets. Ideal for 250 lb pocket doors used in a variety of commercial and residential applications.

Bi-parting doors are possible with the optional bi-parting door kit.

Door thickness: 1-3/8" to 1-3/4"

Door height: 8'

Load rating: Up to 250 lbs per panel

Track: Aluminum box track

Carrier: 4-wheel ball bearing

Compares to: Johnson 1560, Stanley PDF250N

Conforms to: ANSI/BHMA A156.14-2007  
Grade 1, D8671, D8672

With bi-parting kit - Grade 1, D8711, D8721, D8722

### PKF-250 series configuration

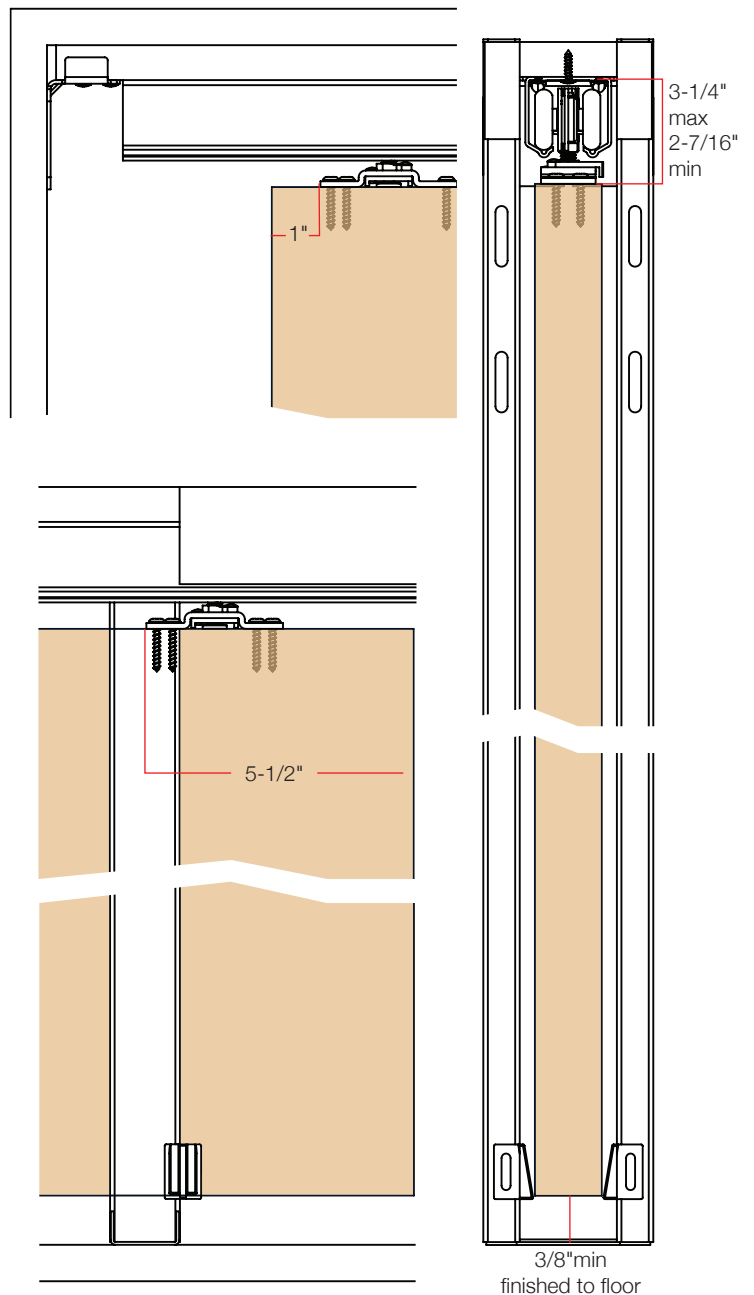
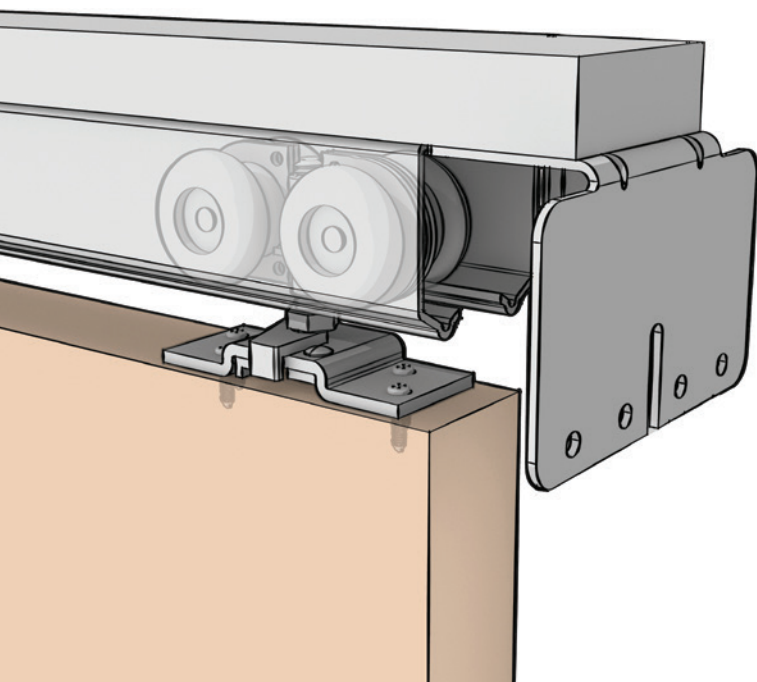

# Frame Kit

SKU	Door Panel Configuration	Pack Qty	Pack Qty Weight (Lb)
PKF-250A-4	Door widths up to 48"	1	51

Frame Kit Contents	PKF-250A-4
Header with 1801K aluminum track	96"
Doorway end bracket-8661	1
Pocket end bracket-8662	1
Floor plate-1840-FP	3
Door bumper-0881	1
Carrier-1820 with quick release top mount plate-1800-DBA	2
Split studs	6 x 8'
Door guide-0883	2
Wrench-8710	1
Screws	Yes

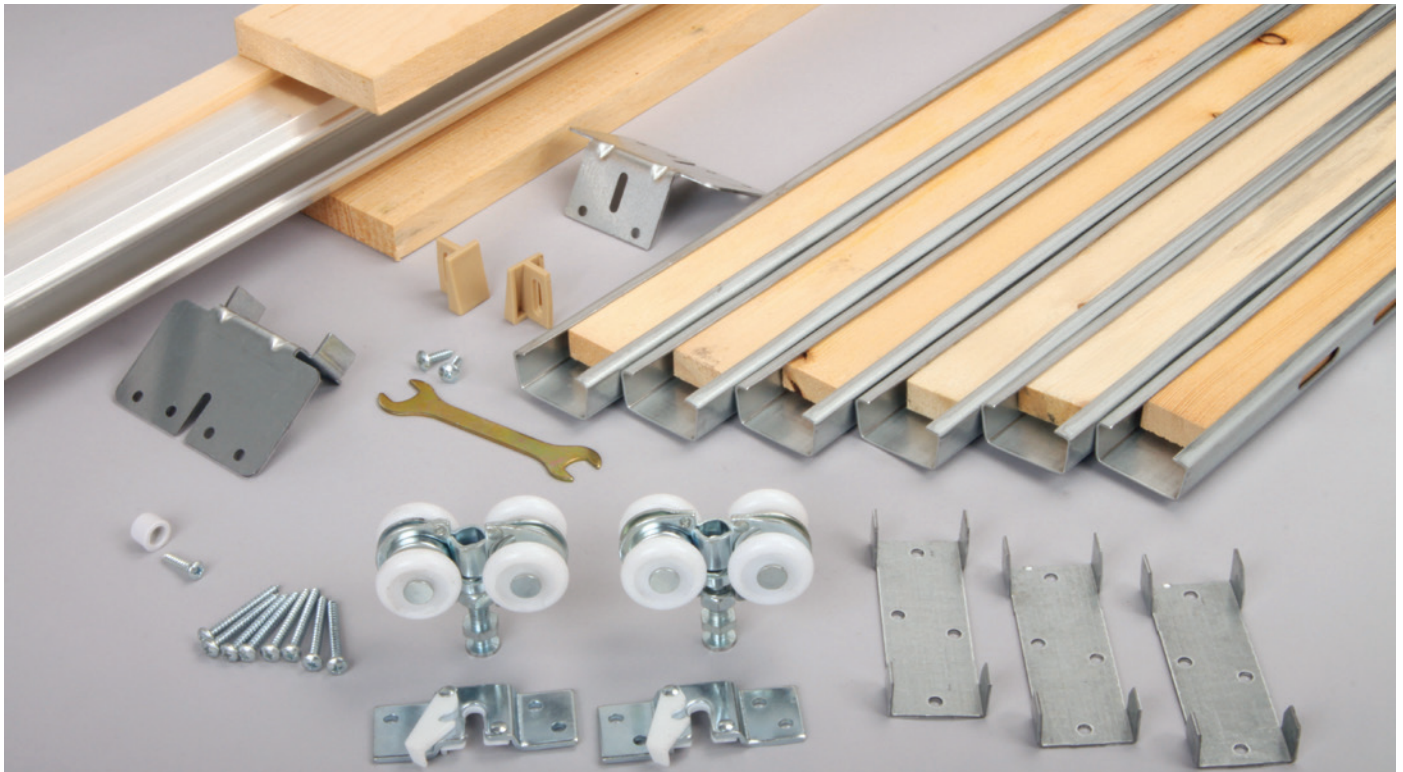

PKF-250

# POCKET FRAME COMPONENTS

SKU	Length	Pack Qty	Pack Qty Weight (Lb)
BX1062-26DA	Pocket door lock, keyed alike, nickel	5	2
BX1062-US26D	Pocket door lock, keyed different, nickel	5	2
BX1062-US3	Pocket door lock, keyed different, brass	5	2
BX1062-US3A	Pocket door lock, keyed alike, brass	5	2
PB-0884-US15	Edge pull (satin nickel)	10	1
PB-0884-US3	Edge pull (bright brass)	10	1
PB-1038-US15	Passage pull (satin nickel)	6	2
PB-1038-US3	Passage pull (bright brass)	6	2
PB-1039-US15	Privacy lock (satin nickel)	6	3
PB-1039-US3	Privacy lock (bright brass)	6	3
PB-1437	Double pocket door adaptor kit	6	4
PB-1639	Bi-parting double door	6	4



**BX1062-26DA** Lock

- **Materials:** Steel
- **Notes:** Nickel, keyed alike.

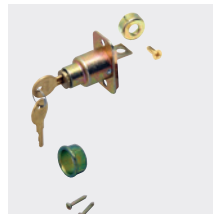

**BX1062-US3A** Lock

- **Materials:** Steel
- **Notes:** Brass, keyed alike.

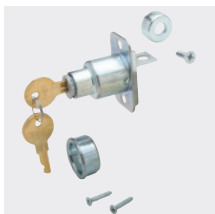

**BX1062-US26D** Lock

- **Materials:** Steel
- **Notes:** Nickel, keyed different (5 key random).



**PB-0884-US15** Edge pull

- **Extends:** 1-1/16" (27 mm)
- **Faceplate:** 21/32" x 3-1/2" (17mm x 89mm)
- **Notes:** Satin nickel. Includes two screws. Ideal for narrow and standard door thicknesses.



**BX1062-US3** Lock

- **Materials:** Steel
- **Notes:** Brass, keyed different (5 key random).

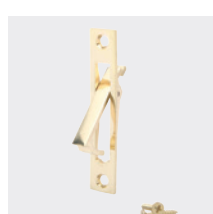

**PB-0884-US3** Edge pull

- **Extends:** 1-1/16" (27 mm)
- **Faceplate:** 21/32" x 3-1/2" (17mm x 89mm)
- **Notes:** Bright brass. Includes two screws. Ideal for narrow and standard door thicknesses.



- PB-1038-US15** Pocket door latch
- **Size:** 2-3/4" x 2-1/2" (70mm x 64mm)
  - **Finish:** Satin nickel
  - **Fasteners:** Included
  - **Notes:** For use with 1-3/8" to 1-3/4" (35mm x 45mm) doors.



- PB-1039-US3** Pocket door privacy latch
- **Size:** 2-3/4" x 2-1/2" (70mm x 64mm)
  - **Finish:** Bright brass
  - **Fasteners:** Included
  - **Notes:** For use with 1-3/4" (45mm) doors.



- PB-1038-US3** Pocket door latch
- **Size:** 2-3/4" x 2-1/2" (70mm x 64mm)
  - **Finish:** Bright brass
  - **Fasteners:** Included
  - **Notes:** For use with 1-3/8" to 1-3/4" (35mm x 45mm) doors.



- PB-1437** Bi-parting door adapter kit
- **Notes:** For PKF-75S.



- PB-1039-US15** Pocket door privacy latch
- **Size:** 2-3/4" x 2-1/2" (70mm x 64mm)
  - **Finish:** Satin nickel
  - **Fasteners:** Included
  - **Notes:** For use with 1-3/4" (45mm) doors.

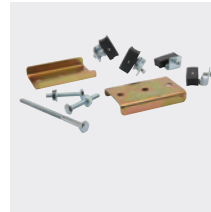

- PB-1639** Bi-parting door adapter kit
- **Notes:** For PKF-100A, 150A, and 250A.

# POCKET CROSS-REFERENCE

KV Series	Johnson	Stanley
PKF-75S	1500	-
PKF-100A   100A7   100A8   100A6W	1500	-
PKF-150A   150A7   150A8   150A6W	1500	PDF150N
PKF-250A	1560	PDF250N

# CALCULATED DOOR WEIGHT TABLE

## 3/4" (19mm) Thick Doors

Width x Height		24x72	24x80	24x84	24x96	30x72	30x80	30x84	30x96	36x72	36x80	36x84	36x96
SqFt		12	13.3	14	16	15	16.7	17.5	20	18	20	21	24
Material	Lb/SqFt	Calculated Door Weight (Lb)				Calculated Door Weight (Lb)				Calculated Door Weight (Lb)			
Hollow core	1.1	13	14	15	17	16	18	19	22	19	22	23	26
White pine	1.5	19	21	22	25	23	26	27	31	28	31	21	37
Fir	1.5	19	21	22	25	23	26	27	31	28	31	32	37
Solid core	1.9	23	25	27	30	28	32	33	38	34	38	40	46
Mahogany	1.9	23	26	27	31	29	32	34	39	35	39	41	46
Ash	2.2	26	29	31	35	33	36	38	44	39	44	46	53
Birch	2.3	28	31	33	37	35	39	41	47	42	47	49	56
Oak	2.9	35	39	41	46	44	48	51	58	52	58	61	70

## 1" (25mm) Thick Doors

Width x Height		24x72	24x80	24x84	24x96	30x72	30x80	30x84	30x96	36x72	36x80	36x84	36x96
SqFt		12	13.3	14	16	15	16.7	17.5	20	18	20	21	24
Material	Lb/SqFt	Calculated Door Weight (Lb)				Calculated Door Weight (Lb)				Calculated Door Weight (Lb)			
Hollow core	1.4	17	19	29	23	22	24	25	29	26	29	30	35
White pine	2.1	25	28	29	33	31	34	36	41	37	41	43	50
Fir	2.1	25	28	29	33	31	34	36	41	37	41	43	50
Solid core	2.5	30	34	36	41	39	43	45	52	47	52	54	62
Mahogany	2.6	31	34	36	41	39	43	45	52	47	52	54	62
Ash	2.9	35	39	41	47	44	49	51	59	53	59	61	70
Birch	3.1	37	42	44	50	47	52	55	62	56	62	66	75
Oak	3.9	47	52	54	62	58	65	68	78	70	78	82	93

1-3/8" (35mm) Thick Doors

Width x Height		24x72	24x80	24x84	24x96	30x72	30x80	30x84	30x96	36x72	36x80	36x84	36x96
SqFt		12	13.3	14	16	15	16.7	17.5	20	18	20	21	24
Material	Lb/SqFt	Calculated Door Weight (Lb)				Calculated Door Weight (Lb)				Calculated Door Weight (Lb)			
Hollow core	2.0	24	27	28	32	30	33	35	40	36	40	42	48
White pine	3.0	36	40	42	48	45	50	53	60	54	60	63	72
Fir	3.0	36	40	42	48	45	50	53	60	54	60	63	72
Solid core	3.5	42	47	49	56	53	58	61	70	63	70	74	84
Mahogany	3.5	42	47	49	56	53	58	61	70	63	70	74	84
Ash	4.0	48	53	56	64	60	67	70	80	72	80	84	96
Birch	4.3	51	57	60	68	64	71	74	85	77	85	89	102
Oak	5.0	60	67	70	80	75	83	88	100	90	100	105	120

1-3/4" (44mm) Thick Doors

Width x Height		24x72	24x80	24x84	24x96	30x72	30x80	30x84	30x96	36x72	36x80	36x84	36x96
SqFt		12	13.3	14	16	15	16.7	17.5	20	18	20	21	24
Material	Lb/SqFt	Calculated Door Weight (Lb)				Calculated Door Weight (Lb)				Calculated Door Weight (Lb)			
Hollow core	2.5	30	33	35	40	38	42	44	50	45	50	53	60
White pine	3.5	42	47	49	56	53	58	61	70	63	70	74	84
Fir	3.5	42	47	49	56	53	58	61	70	63	70	74	84
Solid core	4.3	51	57	60	68	64	71	74	85	77	85	89	102
Mahogany	4.5	54	60	63	72	68	75	79	90	81	90	95	108
Ash	5.0	60	67	70	80	75	83	88	100	90	100	105	120
Birch	5.5	66	73	77	88	83	92	96	110	99	110	116	132
Oak	7.0	84	93	98	112	105	117	123	140	126	140	147	168

2" (51mm) Thick Doors

Width x Height		24x72	24x80	24x84	24x96	30x72	30x80	30x84	30x96	36x72	36x80	36x84	36x96
SqFt		12	13.3	14	16	15	16.7	17.5	20	18	20	21	24
Material	Lb/SqFt	Calculated Door Weight (Lb)				Calculated Door Weight (Lb)				Calculated Door Weight (Lb)			
Hollow core	na	-	-	-	-	-	-	-	-	-	-	-	-
White pine	4.0	48	53	56	64	60	67	70	80	72	80	84	96
Fir	4.0	48	53	56	64	60	67	70	80	72	80	84	96
Solid core	5.3	63	70	74	84	79	88	92	105	95	105	110	126
Mahogany	5.3	63	70	74	84	79	88	92	105	95	105	110	126
Ash	6.0	72	80	84	96	90	100	105	120	108	120	126	144
Birch	6.3	75	83	88	100	94	104	109	125	113	125	131	150
Oak	8.0	96	107	112	128	120	133	140	160	144	160	168	192

# TRACK SELECTION

1.38" W x 1.04" H

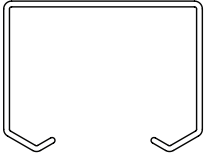

## 1599-z

Steel

35" | 47" | 55" | 59" | 63" | 71" | 95" | 119" | 143" | 191"

1.40" W x 1.07" H

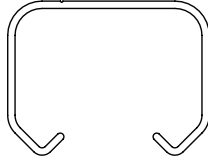

## 1601

Aluminum

35" | 47" | 55" | 59" | 63" | 71" | 84" | 96" | 120" | 144" | 192"

3.15" W x 1.06" H

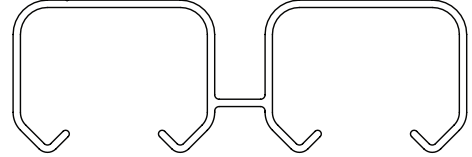

## 1602

Aluminum

35" | 47" | 55" | 59" | 63" | 71" | 84" | 96" | 120" | 144" | 192"

.58" W x 2.75" H

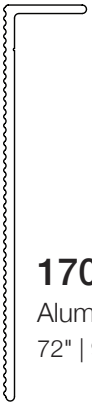

## 1709

Aluminum

72" | 96"

1.84" W x 3.88" H

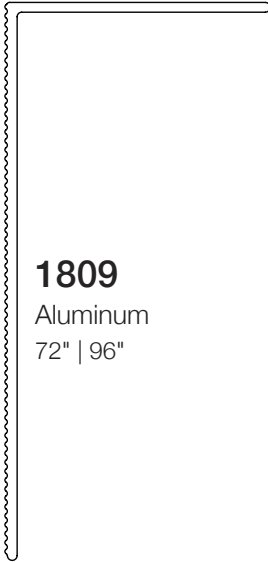

## 1809

Aluminum

72" | 96"

1.77" W x 1.66" H

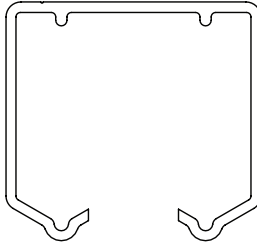

## 1801

Aluminum

48" | 60" | 72" | 96" | 120" | 144" | 192"

1.88" W x 1.31" H

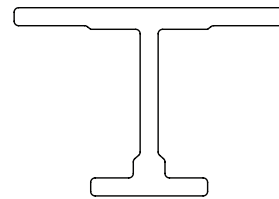

## 1901

Aluminum

60" | 72" | 96" | 120" | 144"

.88" W x .50" H

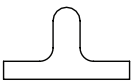

## 1914

Aluminum

72" | 96" | 120" | 144"

.75" W x .63" H

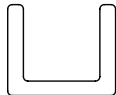

## 1922

Aluminum

96" | 144"

1.75" W x 1.19" H

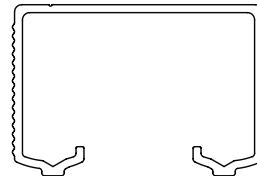

## 2001

Aluminum

35" | 47" | 59" | 71" | 96" | 144"

1.85" W x .96" H

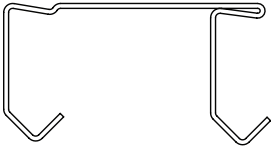

**3800**

Steel

47" | 59" | 71" | 94" | 120"

2.85" W x 1.44" H

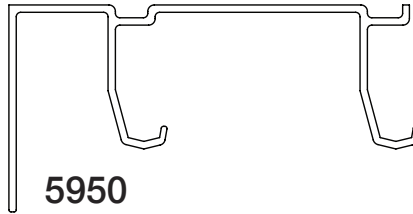

**5950**

Aluminum

48" | 60" | 72" | 96" | 120" | 144"

1.90" W x 1.10" H

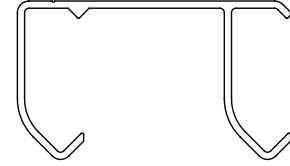

**7810**

Aluminum

46" | 58" | 70" | 93" | 120" | 144"

3.00" W x 1.75" H

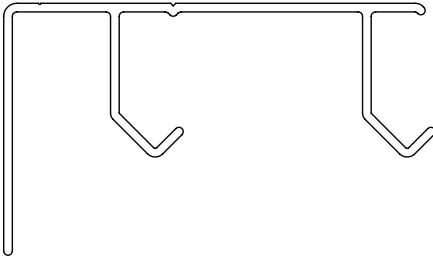

**7820**

Aluminum

48" | 60" | 72" | 96" | 120" | 144"

3.00" W x 1.75" H

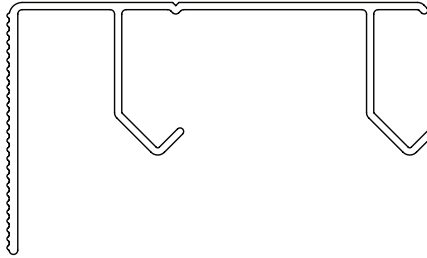

**7820-R**

Aluminum

48" | 60" | 72" | 96" | 120" | 144"

3.12" W x 3" H

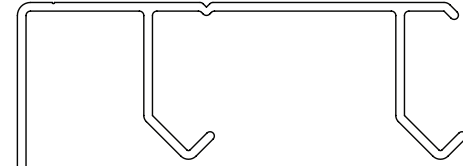

**7830**

Aluminum

48" | 60" | 72" | 96" | 120" | 144"

2.29" W x .99" H



**7840**

Steel

46" | 58" | 70" | 81" | 93" | 120" | 144"

.70" W x .76" H

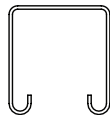

**8001**

Steel

36" | 48" | 60" | 72" | 96"

1.01" W x .48" H

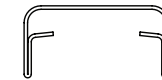

**9001**

Steel

24" | 28" | 30" | 36" | 48"  
60" | 72" | 84" | 96"



# THE KV DIFFERENCE

## **Broad Product Offering**

We are proud of our reputation as a design innovator and a reliable manufacturer. You'll find that our hardware is functional in a wide range of applications: home and kitchen cabinetry, office furniture and files, institutional and commercial furniture, and residential/commercial interior closet and passage way sliding doors.

## **Exceptional Value**

A significant feature of our product line is its superior price/value relationship. We maintain this value through advanced research and development activity, proven manufacturing techniques, thorough employee training, and rigorous quality inspection. Our Limited Lifetime Warranty also demonstrates our confidence in the quality, durability, and reliability of our products.

## **Responsive Service**

Our engineers, product managers, salespeople and customer service representatives all work toward one common goal: your complete satisfaction. No matter what function we perform for you — technical assistance or specialized consulting, product specification or order entry — we're committed to helping you operate your business smoothly and profitably.

## **Reliable Delivery**

We've established high industry standards for on-time delivery and complete order fulfillment. You'll discover that virtually all of our in-stock hardware is available to you within 48 hours. We also closely monitor our inventory to ensure that you'll receive the quantities you require, whether it's 10 items or 10,000.

# COMMERCIAL WARRANTY

## Limited Lifetime Warranty for Commercial Business Products.

This warranty is given to the initial purchaser of new commercial products purchased from Knappe & Vogt Manufacturing Company and its subsidiaries. The warranty covers defects in materials and workmanship. The warranty does not apply to defects resulting from misuse, damage or abuse, normal wear and tear, accident, modification, improper installation or maintenance, third party materials or damage during shipping. The warranty is not transferable and does not cover any subsequent purchasers of the products.

Definitions of the specific warranty time periods by product can be obtained from Customer Service at 800-253-1561. The warranty time period begins on the date of purchase for all products. Applicable warranty time periods are based on one 8-hour shift per day usage, and warranty time periods are adjusted and shortened proportionally for any multiple shift or excess usage.

During the warranty period, Knappe & Vogt, will, at its option, repair or replace any defective product with a comparable product or component. This limited warranty is for repair or replacement of defective products only and does not cover any other costs such as removal, installation, or other related expenses.

For warranty service, please contact Knappe & Vogt Manufacturing Company, 2700 Oak Industrial Drive, Grand Rapids, MI 49505, Attention: Customer Service. Information regarding the claimed defect and date of purchase of the product must be provided.

Any defective product must be returned postage or freight prepaid to Knappe & Vogt.

THIS LIMITED WARRANTY CONSTITUTES THE ONLY WARRANTY FOR THE PRODUCTS AND ALL OTHER WARRANTIES OR REPRESENTATIONS, EXPRESS OR IMPLIED, BY OPERATION OF LAW OR OTHERWISE, INCLUDING BUT NOT LIMITED TO ANY IMPLIED WARRANTY OF MERCHANTABILITY OR FITNESS FOR A PARTICULAR PURPOSE, ARE EXPRESSLY DISCLAIMED (some states do not allow limitations on how long an implied warranty lasts).

THIS LIMITED WARRANTY CONSTITUTES THE SOLE REMEDY AVAILABLE WITH REGARD TO ANY DEFECTIVE PRODUCTS. KNAPE & VOGT SHALL NOT BE LIABLE FOR ANY INCIDENTAL, INDIRECT, CONSEQUENTIAL OR SPECIAL DAMAGES, INCLUDING WITHOUT LIMITATION, LOSS OF TIME, INCONVENIENCE, OR LOST REVENUES OR PROFITS (some states do not allow the exclusion or limitation of incidental or consequential damages).

Copyright © 2013 Knappe & Vogt Manufacturing Company, all rights reserved. Standard KV Commercial Warranty

# RETURN POLICY

## Return Policy for special order or nonstock items:

We're sorry, we cannot accept returns on nonstock products or special order products unless there is a Knap & Vogt error — which we will be happy to correct. To return product(s), please follow these procedures:

Please contact Knap & Vogt Customer Service at 1-800-253-1561. A Customer Service Representative will assist you with getting a Return Goods Authorization (RGA) number. The original P.O. is required to receive a RGA number. Please return product within 30 days of issuance of the RGA number.

## Restocking Fees:

- All resalable product returned in original resalable packaging will be assessed a 20% fee for restocking and handling.
- Minimum fee is \$25.
- All resalable products returned not in resalable original packaging will be assessed a 20% fee for repackaging in addition to the 20% restocking and handling fee.
- Above referenced fees will be waived on returns resulting from a Knap & Vogt error.

## Shipping:

You are responsible for all return shipping charges to return the product unless we made an error in shipping your order, i.e., the product we shipped is not the one you ordered, or is defective.

## In the US, please ship to: Knap & Vogt

Return Goods Department, 2700 Oak Industrial Dr., N.E., Grand Rapids, MI 49505

## In Canada, please ship to:

Knap & Vogt/ Vanguard, Attn: Return Goods Department, 265 Export Blvd, Mississauga, ON L5S 1Y4

- Ensure the product(s) are properly packaged to prevent shipping damage.
- Include RGA number with return.

- Ensure all products returned match quantities and products listed on the assigned RGA.

## Credit:

- A credit memo will be issued upon inspection and approval of the returned product.
- Upon receipt and inspection Knap & Vogt will determine credit amount and notify you of any discrepancies.
- DO NOT make any financial adjustments to your account prior to Knap & Vogt issuing a credit memo for returned goods.
- Please allow a minimum of 14 days for us to receive and process your return.
- We will credit or refund the value of the product total and any taxes you were charged less applicable fees. (excluding delivery charges).
- Refunds will be given in the same form of payment. Adjustments to credit cards should appear within two billing cycles.

## Replacement Orders:

- Any replacement orders will be charged to your account.
- A credit memo will be issued for returned products that have been approved.

## RGA Status Information:

- Visit [www.customerconnection.com](http://www.customerconnection.com).
- Enter your account information.
- If you do not already have your account set up for this free service, please register at [www.customerconnection.com](http://www.customerconnection.com).
- Your satisfaction is our priority. We are happy to accept returns or exchanges for any resalable or defective products within 60 days of the shipping date.

# INDEX

1574 Spacer	100	BK-1355-4.5	109, 113, 117, 121, 125, 129, 130	BK-7200-BTW	51, 55, 59, 63, 67, 102
2074 Spacer	87, 91, 95, 100	BK-1355	109, 113, 121, 129 130	BK-7400-A	51, 102
BK-0200-A	43, 71, 100	BK-1355-87	109, 113, 121, 129 130	BK-7400-B	51, 55, 59, 63, 67, 102
BK-0200-B	43, 71, 100	BK-1355-97	109, 113, 121, 129 130	BK-7768	9, 13, 32
BK-0351	43, 47, 51, 55, 59, 63, 67, 71, 75, 79, 83, 87, 91, 95, 100	BK-1507-TM	109, 130	BK-8000-TP	9, 32
BK-0351-WT	43, 47, 51, 55, 59, 63, 67, 71, 75, 79, 83, 87, 91, 95, 100	BK-1572-QR	79, 101	BK-8049-2	13, 32
BK-0354	43, 47, 51, 55, 59, 67, 71, 75, 79, 83, 87, 91, 95, 100	BK-1582	109, 130	BK-8049-4	13, 32
BK-0400-A	71, 100	BK-1606-QR	19, 32, 83, 101, 113, 130	BK-8220-ZC	13, 19, 23, 27, 32
BK-0400-B	71, 100	BK-1800-DBA	19, 31, 32, 79, 83, 95, 101, 113, 125, 129, 131	BK-8402-JS	13, 32
BK-0815	19, 23, 27, 31, 32, 100	BK-1820	31, 32, 95, 101, 125, 129, 131	BK-8404-JS	13, 33
BK-0881	109, 113, 117, 121, 125, 129, 130	BK-1900	99, 101	BK-8816-21	9, 33
BK-0881-WT	109, 113, 117, 121, 125, 129, 130	BK-1911	99, 101	BK-8816-22	9, 33
BK-0883	109, 113, 117, 121, 125, 126	BK-1914-72	99, 101	BN-0355	43, 47, 51, 55, 59, 63, 67, 71, 79, 83, 87, 91, 95, 102
BK-0889	130	BK-1914-96	99, 101	BN-0868-US10B	43, 47, 51, 55, 59, 63, 67, 71, 75, 79, 83, 87, 91, 95, 102, 109, 113, 131
BK-0864-US15	100	BK-1914-120	99, 101	BN-0868-US15	43, 47, 51, 55, 59, 63, 67, 71, 75, 79, 83, 87, 91, 95, 102, 109, 113, 131
BK-0864-US3	43, 47, 51, 55, 59, 67, 71, 75, 79, 83, 87, 91, 95, 100	BK-1914-144	99, 101	BN-0868-US26	43, 47, 51, 55, 59, 63, 67, 71, 75, 79, 83, 87, 91, 95, 102, 109, 113, 131
BK-0865-WT	43, 47, 51, 55, 63, 67, 71, 75, 79, 83, 87, 91, 95, 100	BK-1915	99, 101	BN-0868-US3	43, 47, 51, 55, 59, 63, 67, 71, 75, 79, 83, 87, 91, 95, 102, 109, 113, 131
BK-1355-3.5	109, 113, 117, 121, 125, 129, 130	BK-1922-144	19, 23, 27, 31, 32, 95, 101		
		BK-1922-96	19, 23, 27, 31, 32, 95, 102		
		BK-7200-A	51, 67, 102		
		BK-7200-ATW	51, 67, 102		
		BK-7200-B	51, 55, 59, 63, 67, 102		

# INDEX (CONTINUED)

BN-0868-US5	43, 47, 51, 55, 59, 63, 67, 71, 75, 79, 83, 87, 91, 95, 103, 109, 113, 127	PB-1437	109, 128, 132, 146, 147	PB1068-US3A	43, 47, 51, 55, 59, 63, 67, 71, 75, 79, 83, 87, 91, 95, 99, 104
BN-0880	51, 55, 59, 63, 67, 71, 75, 79, 83, 87, 91, 95, 103	PB-1558	9, 13, 19, 23, 27, 31, 33		
BX1062-26DA	109, 113, 117, 121, 125, 129, 131, 146	PB-1559	9, 13, 19, 23, 27, 31, 33		
BX1062-US26D	109, 113, 117, 121, 125, 129, 131, 146	PB-1618	19, 33		
BX1062-US3	109, 113, 117, 121, 125, 129, 131, 146	PB-1639	113, 117, 121, 125, 129, 132, 146, 147		
BX1062-US3A	109, 113, 117, 121, 125, 129, 131, 146	PB-1828	23, 31, 33		
PB-0352	103	PB-1921	23, 31, 33		
PB-0400-ATW	47, 75, 103	PB-2004	23, 33, 87, 103, 117, 128, 132		
PB-0400-BTW	47, 75, 103	PB-2004-BB	27, 33, 91, 103, 121, 128, 132		
PB-0884-US15	109, 113, 117, 121, 125, 129, 131, 146	PB-8268	9, 13, 19, 23, 33		
PB-0884-US3	109, 113, 117, 121, 125, 129, 131, 146	PB1064-26DA	9, 13, 19, 23, 27, 31, 33		
PB-0909	71, 75, 79, 83, 87, 91, 95, 103	PB1064-US26D	9, 13, 19, 23, 27, 31, 34		
PB-1038-US15	109, 113, 117, 121, 125, 129, 132, 146, 147	PB1064-US3	9, 13, 19, 23, 27, 31, 34		
PB-1038-US3	109, 113, 117, 121, 125, 129, 132, 146, 147	PB1064-US3A	9, 13, 19, 23, 27, 31, 34		
PB-1039-US15	109, 113, 117, 121, 125, 129, 132, 146, 147	PB1068-26DA	43, 47, 51, 55, 59, 63, 67, 71, 75, 79, 83, 87, 91, 95, 99, 103		
PB-1039-US3	109, 113, 117, 121, 125, 129, 132, 146, 147	PB1068-US26D	43, 47, 51, 55, 59, 63, 67, 71, 75, 79, 83, 87, 91, 95, 99, 104		
		PB1068-US3	43, 47, 51, 55, 59, 63, 67, 71, 75, 79, 83, 87, 91, 95, 99, 104		



2700 Oak Industrial Dr. NE  
Grand Rapids, MI 49505-6026 USA  
1.800.253.1561 | 616.459.3311  
Fax: 877.636.3290 | [www.kv.com](http://www.kv.com)

